

HON NOW™

Digital Pricer

Effective January 2021



HON NOW PRICER Table of Contents

NOW Table of Contents	1-3	Voi® Laminate Worksurfaces	43
NOW Program Overview	4-6	Voi® Worksurface Supports — Components	44
NOW Legend	7	Voi® Worksurface Supports — O-Leg	44
NOW Desking	8	Voi® Worksurface Supports — Angled Legs	44
Coze Table Desk	9-10	Voi® Laminate Support Pedestals	45
Coze Worksurfaces	11	Voi® Modesty Panels	46
Mod Typical	12-14	Voi® Laminate Low Credenzas	46
Mod Laminate Desk Shells	15-16	Voi® Laminate Mobile Storage	47
Mod Laminate Credenza Shells	16-17	10500 Series™ Typical	48
Mod Laminate Return Shells	18	10500 Series™ Laminate Wood Desks — Full Pedestals	49
Mod Laminate Bridges	19	10500 Series™ Laminate Wood Desks — 3/4 Pedestals	50-51
Mod Laminate Corner Shells	20	10500 Series™ Laminate Storage	51
Mod Laminate Peninsulas with End Panel	20	10500 Series™ Light Accessories	52
Mod Laminate Hutches	21	10500 Series™ Laminate Lateral Files	52
Mod Laminate Wall Mounted Storage	22	10500 Series™ Laminate Bookcases	53
Mod Wall Laminate and Glass Hutch Doors Mod	23	10500 Series™ Pull Accessories	54
Tackboards	24	NOW Workstations	55
Mod Markerboard	24	Accelerate® Typical	56-61
Mod Laminate Support Pedestals	25	Accelerate® Tackable Raceway Panels	62-63
Mod Laminate Hanging Pedestals	25	Accelerate® ETA Overheads and Shelves	64
Mod Laminate Mobile Pedestals	26	Accelerate® Mobile Pedestals	64
Mod Laminate Bookcases and Storage Cabinets	27	Accelerate® Worksurface Supports	65
Mod Laminate Wardrobes	28	Accelerate® Top Caps	66
Mod Laminate Laterals	28-29	Accelerate® Stacking Panels	66
Mod Laminate Worksurfaces	29-31	Accelerate® Connectors	67
Mod External Stiffener	31	Accelerate® Variable Height Finished End	68
Mod Metal Support Legs	32	Accelerate® Wall Starter Kits	68
Mod Storage Support Legs	32	Systems Primary Worksurfaces	69
Mod Laminate Low Credenzas	33	Systems Corner Worksurfaces	70
Mod Low Credenza Tops	34-35	Systems Straight Countertops	70
Mod Low Credenza Cushions	35	Systems Countertop Bracket Kits	71
Mod Laminate Table Tops	36	Systems Worksurface Supports	72
Mod Laminate Round Table Bases	37	Systems Worksurface Brackets	72
Mod Laminate Table Tops	38	Systems Worksurface Supports	73
Mod Laminate Rectangle Table Bases	39	Systems Standard Height Support Pedestals	73
Mod Laminate Reception Desk Shells	40	Empower® Typical	74-77
Mod Laminate Reception Return Shells	40	Empower® Legs for Linear Applications	78
Mod Transaction Tops	40	Empower® Support Beams	78
Voi® Typical	41-42		

HON NOW PRICER Table of Contents

Empower® Height Adjustable Bases	78	SmartLink® Student Desks and Accessories	109
Empower® Systems Worksurfaces	79	SmartLink® Mobile Storage Cabinets	110
Empower® Wire Troughs	80	SmartLink® Teacher Station	110
Empower® Wire Troughs for Height Adjustable Bases	80	SmartLink® Student Seating	111
Empower® Side Screens	81	NOW Workplace Tools	113
Empower® Fabric Center Screens	82	Chair Mats	114
Empower® Electrical and Data	83	Monitor Arms	114-115
Empower® Electrical Accessories	83	Hand Sanitizer Stand & Mounts	115
Empower® Mobile Pedestals	84	Universal Panel Stackers	116
Empower® Laminate Mobile Storage	84	Acrylic Screens	117
Systems Electrical Components	85-86	Plexi-Glass Screens	117
Systems Accessories - Electrical	87	Task Lights	118
Systems Accessories - Monitor Arms	87	Hands-Free Door Pulls	118
NOW Storage	89	NOW Seating	119
Brigade® Standard Height Pedestals	90	Accommodate® Guest Chairs	120
Brigade® Lateral Files w/Drawers	91-92	Assemble™ Nesting/Stacking Chairs	120
Flagship® Mobile Pedestals	93	Circulate™ Club Chairs	121
Fuse™ Mobile Pedestals	94	Client™ Guest Chairs	122
Fuse™ Undermount Storage	94	Cliq™ Task Chairs	123
310 Series Vertical Files	95	Convergence® Standard Task Chairs	123
510 Series Vertical Files	96	Corral™ Contemporary Lounge	124
Lateral File Accessories	97	Crio Mesh Chairs	125
NOW Tables	99	Define™ Executive Chairs	126
Between™ Table Tops	100	Entire™ Mesh Chairs	126
Between™ Table Bases	100	Exposure™ Mesh Chairs	126
Between™ Nesting Tables	100	Flock® Collaborative Seating	127
Coordinate™ Height Adjustable Bases	101	Flock® Mini Cylinders	128
Coordinate™ Desktop Riser & Sit-to-Stand Devices	101	Gateway™ Task Chairs	129
Coordinate™ Worksurfaces	102	GuestStacker® 4030 Series Chairs	130
Huddle Multi-Purpose Table Tops	103	Ignition® Task Chairs	131
Huddle Multi-Purpose Table Bases	103	Ignition® Task Stools	131
Huddle Bundles	104	Ignition® 2.0 Task Chairs	132
Contemporary Occasional Tables	105	Ignition® 2.0 Task Stools	132
Preside® Table Tops	106	Ignition® 2.0 ReActiv® Task Chairs	133
Preside® Table Bases	106	Ignition® 2.0 Upholstered Task Chairs	133
NOW Education	107	Ignition® Chairs	134
Motivate® Presentation Cart	108	Ignition® Stools	134
SmartLink® Student Desks	109	Instigate™ Mesh Guest Chairs	135

HON NOW PRICER Table of Contents

Lota® Chairs	135	Volt® 5700 Series	148
Matter™ Chairs	135-136	Volt® 5710 Series	149
Motivate® High-Density Sled Base Chairs	136	Wave™ Mesh Chairs	150
Motivate® Nesting/Stacking Flex-Back Chairs	136	Executive Chairs	151-152
Network™ Task Chairs	137	Guest Chairs	152
Pillow-Soft® 2090 Series Chairs	138	Mesh Chairs	152
Prominent™ Mesh Chairs	139-140	Nesting Chairs	153
Ruck™ Laminate Seating	141	Task Chairs	154-155
Scatter™ Guest Chairs	142	Big & Tall Chairs	155
Solutions Guest Chairs	142	Executive Chairs	156-157
Solve® Task Chairs	143	Racing Style Chairs	158
Solve® Stools	143	Workplace Tools Chair Mats	159
Torch™ Mesh Chairs	144	NOW Cross Reference Index	160-162
Traction™ Executive Chairs	145	HON NOW Full Lifetime Warranty Information	163
Validate™ Guest Chairs	146	HON NOW Limited 5-Year Warranty Information	164
ValuTask®	147		

HON NOW™

Superior Office Solutions at the Speed You Need

PROGRAM OVERVIEW

To keep your business at peak productivity, waiting isn't always an option. The HON NOW Quickship program was designed for movers and shakers like you who want exceptional quality, durability, and versatility without compromising valuable time. Whether you're outfitting a brand-new workspace or simply expanding the one you already have, we've got a variety of dependable and supportive office furniture solutions designed to fit your needs and your schedule - in a hurry, without the hassle.

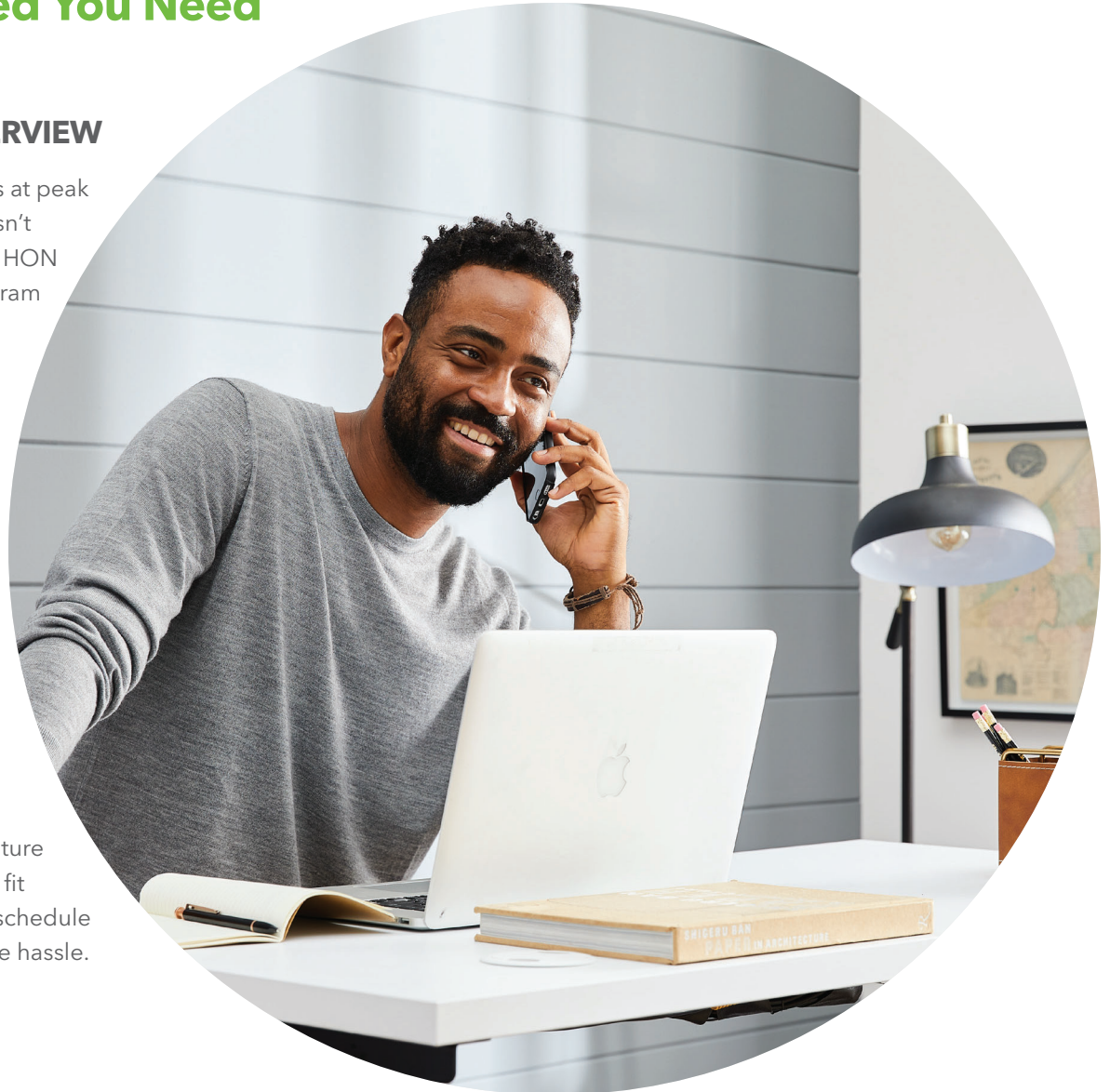

Designing High-Performing Spaces to fit your needs



DESKS & SEATING



WORKSTATIONS & CUBICLES



TABLES



WORK FROM HOME



EDUCATION

HON NOW™

PROGRAM OVERVIEW



Product Offering

HON NOW offers a comprehensive product offering to meet your office furniture needs while keeping speed as a priority. Outfit an entire Private Office, Open Office, Collaborative, Common or Welcome Space for the full solution. Or if you are looking for just a chair, desk, workstation/benching, table or storage option we have that too. For the full HON NOW product assortment, visit the NOW spotlight page on the HON Ready Portal.

Sales Tools

Enabling you with all the tools needed to sell HON NOW.

- **HON NOW Catalog** – All-in-one sales tool for your customers that includes inspirational spaces, fabrics and finishes and easy-to-order products. See the digital catalog: <http://hon.to/now>
- **HON NOW Digital Pricer** – your go-to resource to spec and price all of the HON NOW products
- **HON NOW Spec Tool Catalog** – Using the HON NOW makes it easy to spec and design projects with HON NOW
- **More tools and materials** can be found on hon.com or the HON Ready Portal. Plus, HON NOW is on the HON App!

Order Size

HON NOW allows you to provide just a chair or desk all the way to an entire private office, open office workstations to a collaborative space in your office all delivered with speed.

- No minimum or maximum order threshold. However, large quantity orders or large dollar volume orders may receive lead times greater than the HON NOW program delivery threshold. Please work with your project or order management team to confirm availability for your specific project.
- Orders are subject to availability based on the HON NOW assortment.

Lead Time

The HON NOW program is designed to deliver on avg. in 10 business days with an option for expedited delivery. This means that you can look for deliveries on your next regularly scheduled delivery day unless your customer needs it faster in which you can choose the expedited option. Delivery times will vary for both options based on proximity to Muscatine, IA, where stock is centrally located.

NOW / Standard Option

- Deliveries will arrive within 7-11 business days depending on Dealer location
- Deliveries are subject to HON standard freight terms

NOW + Speed / Expedited Delivery Option

- Deliveries will arrive within 2-6 business days based on Dealer or Customer location
- NOW + Speed option will have a 5% list freight charge that will be capped at \$5,000 maximum

Freight Terms

- NOW delivery will vary based on Dealer Location and will ship on partial or full truckloads to Dealer Location.
- NOW + Speed will deliver via LTL carrier or FedEx
- NOW + Speed freight charge includes liftgate and delivery to the door/threshold
- Delivery and shipment timeframes do not include weekends, national holidays, or HON company holidays

Delivery Exceptions

Orders delivering to remote areas may be subject to longer lead times. For customers located in Alaska and Hawaii, orders will ship to the point of embarkation (U.S. Freight Forwarder). Customers located in Canada will follow the NOW program terms, however, delivery could extend from the current lead time expectations based on location if located in remote areas.

Dealer Programs & Seller Rewards

Eligible for Modified Dealer Programs, NOW sales counts towards overall Dealership volume. HONORS participants earn rewards for selling NOW in the HON HONORS program. A flat percentage payout will be paid to eligible HONORS participants based on the NOW program guidelines. Payout schedule and program terms follow the standard HONORS program terms and conditions.

NOW = HONORS payout of 2% of invoice

NOW + Speed = HONORS payout of 1% of invoice

CAP/GIZA Catalog

HNW

5 Hour IDS Design

HON NOW offers excellent 5-hour Design Services from the HON Integrated Design Solutions Team making designing HON NOW easy and fast. Go to MyProjects on the HON Ready Portal to submit your HON NOW design. Make sure to include HON NOW when submitting and that's it!

Discounts

Contact your HON Business Development Manager for your discount and contract codes.

Eligible Products for Workstation and Benching Discount

- Accelerate® Panels
- Accelerate Worksurfaces
- Brigade® Pedestals
- Empower® Benching
- Flagship® Pedestals
- Pedestal Accessories
- Systems Electrical
- Systems Worksurfaces

Order Information

Orders cannot be canceled or changed once submitted. Orders must be submitted electronically under the NOW contract code to receive the correct discounting, terms and shipment option. Orders cannot be combined with other products or programs. Order fulfillment based on stock availability at the time of the order. No request dates allowed.

HELPFUL FREIGHT TIPS

HOW TO IDENTIFY SMALL PACKAGE SHIPPABLE ITEMS

The following icon can be found throughout the pricer to indicate small package items.



Shippable by small-package carrier

HFLY01

MINI CYLINDER

DIMENSIONS

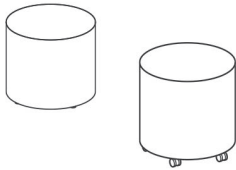

Depth:	18½	Seat to Floor Height:	17
Width:	18½	Usable Seat Depth:	18½
Height:	17	Ship Weight:	13
Seat Depth:	18½	Cube:	5.0
Seat Width:	18½	Weight Rating:	300 lbs.

HOW TO TRACK YOUR LTL ORDER

1. Go to www.xpo.com
2. Click “Contact Us” in the top right corner
3. Click “Global Locations” under Helpful Links
4. Type in zip code or location in the “Enter a Location” search
5. Once you’ve determined your closest terminal, call and request to setup a customer profile with preferred delivery hours and contact

DELIVERY EXCEPTIONS

Orders delivering to remote areas may be subject to longer lead times. For customers located in Alaska and Hawaii, orders will ship to the point of embarkation (U.S. Freight Forwarder). Customers located in Canada will follow the NOW program terms, however, delivery could extend from the current lead time expectations based on location if located in remote areas. Delivery and shipment timeframes do not include weekends, national holidays, or HON company holidays.

Terms are updated as of December, 2021

LEGEND

THE FOLLOWING ICONS ARE USED THROUGHOUT THIS PUBLICATION



Meets or exceeds ANSI/BIFMA and ISTA performance standards



Certified SCS Indoor Advantage™



Complies to the BIFMA e3 Sustainability Standard



Caution



Easy to assemble



Shippable by small-package carrier



HON “One Key” Interchangeable core removable locks



Omit core removable lock option available. Allows keyed-alike workstations.

NOW Desking Fabrics and Finishes

LAMINATES

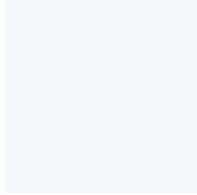

Designer White
LDW1
*Coze
Voi®*

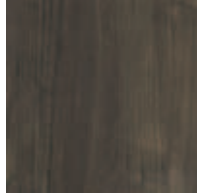

Florence Walnut
LFW1
*10500 Series™
Coze
Voi®*



Natural Recon
LNR1
Coze



Pinnacle
PINC
*10500 Series™
Voi®*

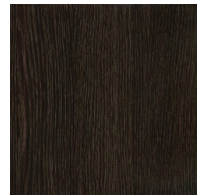

Java Oak
LJA1
Mod



Russet Cherry
LRC1
Mod



Sepia Walnut
LSE1
Mod



Simply White
LPW1
Mod



Slate Teak
LSL1
Mod



Traditional Mahogany
LTM1
Mod

PAINT

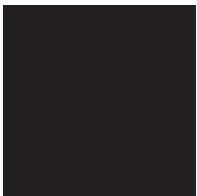

Black
BLKP
Mod



Designer White
PJW
Voi®



Silver
PR6/SLVR
*Mod
Voi®*

FABRICS

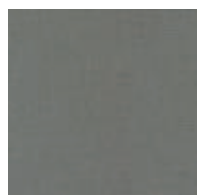

Appoint Platinum
PNS004
Voi®

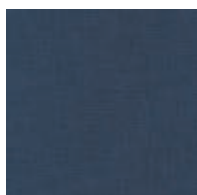

Appoint Jet
PNS007
Voi®

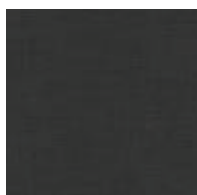

Appoint Carbon
PNS008
Voi®

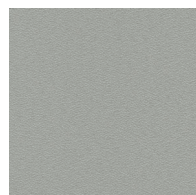

Cool Neutral
CN02
Mod



Warm Neutral
WM01
Mod



TABLE DESK

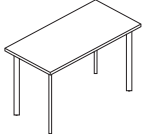

MODEL	DESCRIPTION	SHIP WEIGHT	CUBE	LIST PRICE
	Table Desk with Post Legs			
HLCRPL5424WFH.LNR1NR.PR6	54"W x 24"D Natural Recon laminate and edge, Silver paint	71	5.7	\$530
HLCRPL5424WFH.LNR1NR.PJW	54"W x 24"D Natural Recon laminate and edge, Designer White paint	71	5.7	\$530
HLCRPL5424WFH.LNR1NR.P71	54"W x 24"D Natural Recon laminate and edge, Black paint	71	5.7	\$530
HLCRPL5424WFH.LFW1FW.PR6	54"W x 24"D Florence Walnut laminate and edge, Silver paint	71	5.7	\$530
HLCRPL5424WFH.LFW1FW.PJW	54"W x 24"D Florence Walnut laminate and edge, Designer White paint	71	5.7	\$530
HLCRPL5424WFH.LFW1FW.P71	54"W x 24"D Florence Walnut laminate and edge, Black paint	71	5.7	\$530
HLCRPL5424WFH.LDW1DW.PR6	54"W x 24"D Designer White laminate and edge, Silver paint	71	5.7	\$530
HLCRPL5424WFH.LDW1DW.PJW	54"W x 24"D Designer White laminate and edge, Designer White paint	71	5.7	\$530
HLCRPL5424WFH.LDW1DW.P71	54"W x 24"D Designer White laminate and edge, Black paint	71	5.7	\$530
HLCRPL4824WFH.LNR1NR.PR6	48"W x 24"D Natural Recon laminate and edge, Silver paint	66	5.4	\$505
HLCRPL4824WFH.LNR1NR.PJW	48"W x 24"D Natural Recon laminate and edge, Designer White paint	66	5.4	\$505
HLCRPL4824WFH.LNR1NR.P71	48"W x 24"D Natural Recon laminate and edge, Black paint	66	5.4	\$505
HLCRPL4824WFH.LFW1FW.PR6	48"W x 24"D Florence Walnut laminate and edge, Silver paint	66	5.4	\$505
HLCRPL4824WFH.LFW1FW.PJW	48"W x 24"D Florence Walnut laminate and edge, Designer White paint	66	5.4	\$505
HLCRPL4824WFH.LFW1FW.P71	48"W x 24"D Florence Walnut laminate and edge, Black paint	66	5.4	\$505
HLCRPL4824WFH.LDW1DW.PR6	48"W x 24"D Designer White laminate and edge, Silver paint	66	5.4	\$505
HLCRPL4824WFH.LDW1DW.PJW	48"W x 24"D Designer White laminate and edge, Designer White paint	66	5.4	\$505
HLCRPL4824WFH.LDW1DW.P71	48"W x 24"D Designer White laminate and edge, Black paint	66	5.4	\$505
HLCRPL4224WFH.LNR1NR.PR6	42"W x 24"D Natural Recon laminate and edge, Silver paint	61	5.2	\$480
HLCRPL4224WFH.LNR1NR.PJW	42"W x 24"D Natural Recon laminate and edge, Designer White paint	61	5.2	\$480
HLCRPL4224WFH.LNR1NR.P71	42"W x 24"D Natural Recon laminate and edge, Black paint	61	5.2	\$480
HLCRPL4224WFH.LFW1FW.PR6	42"W x 24"D Florence Walnut laminate and edge, Silver paint	61	5.2	\$480
HLCRPL4224WFH.LFW1FW.PJW	42"W x 24"D Florence Walnut laminate and edge, Designer White paint	61	5.2	\$480
HLCRPL4224WFH.LFW1FW.P71	42"W x 24"D Florence Walnut laminate and edge, Black paint	61	5.2	\$480
HLCRPL4224WFH.LDW1DW.PR6	42"W x 24"D Designer White laminate and edge, Silver paint	61	5.2	\$480
HLCRPL4224WFH.LDW1DW.PJW	42"W x 24"D Designer White laminate and edge, Designer White paint	61	5.2	\$480
HLCRPL4224WFH.LDW1DW.P71	42"W x 24"D Designer White laminate and edge, Black paint	61	5.2	\$480

NOTES: Product ships with desk top and 4 legs in 2 cartons.

COZE Table Desk

OPEN MARKET



Icon Legend on page 7

TABLE DESK



MODEL	DESCRIPTION	SHIP WEIGHT	CUBE	LIST PRICE
	Table Desk with Post Legs and U-Storage			
HLCRPL5424WFH-US.LNR1NR.PR6	54"W x 24"D Natural Recon laminate and edge, Silver paint	78	5.7	\$585
HLCRPL5424WFH-US.LNR1NR.PJW	54"W x 24"D Natural Recon laminate and edge, Designer White paint	78	5.7	\$585
HLCRPL5424WFH-US.LNR1NR.P71	54"W x 24"D Natural Recon laminate and edge, Black paint	78	5.7	\$585
HLCRPL5424WFH-US.LFW1FW.PR6	54"W x 24"D Florence Walnut laminate and edge, Silver paint	78	5.7	\$585
HLCRPL5424WFH-US.LFW1FW.PJW	54"W x 24"D Florence Walnut laminate and edge, Designer White paint	78	5.7	\$585
HLCRPL5424WFH-US.LFW1FW.P71	54"W x 24"D Florence Walnut laminate and edge, Black paint	78	5.7	\$585
HLCRPL5424WFH-US.LDW1DW.PR6	54"W x 24"D Designer White laminate and edge, Silver paint	78	5.7	\$585
HLCRPL5424WFH-US.LDW1DW.PJW	54"W x 24"D Designer White laminate and edge, Designer White paint	78	5.7	\$585
HLCRPL5424WFH-US.LDW1DW.P71	54"W x 24"D Designer White laminate and edge, Black paint	78	5.7	\$585
HLCRPL4824WFH-US.LNR1NR.PR6	48"W x 24"D Natural Recon laminate and edge, Silver paint	73	5.4	\$560
HLCRPL4824WFH-US.LNR1NR.PJW	48"W x 24"D Natural Recon laminate and edge, Designer White paint	73	5.4	\$560
HLCRPL4824WFH-US.LNR1NR.P71	48"W x 24"D Natural Recon laminate and edge, Black paint	73	5.4	\$560
HLCRPL4824WFH-US.LFW1FW.PR6	48"W x 24"D Florence Walnut laminate and edge, Silver paint	73	5.4	\$560
HLCRPL4824WFH-US.LFW1FW.PJW	48"W x 24"D Florence Walnut laminate and edge, Designer White paint	73	5.4	\$560
HLCRPL4824WFH-US.LFW1FW.P71	48"W x 24"D Florence Walnut laminate and edge, Black paint	73	5.4	\$560
HLCRPL4824WFH-US.LDW1DW.PR6	48"W x 24"D Designer White laminate and edge, Silver paint	73	5.4	\$560
HLCRPL4824WFH-US.LDW1DW.PJW	48"W x 24"D Designer White laminate and edge, Designer White paint	73	5.4	\$560
HLCRPL4824WFH-US.LDW1DW.P71	48"W x 24"D Designer White laminate and edge, Black paint	73	5.4	\$560
HLCRPL4224WFH-US.LNR1NR.PR6	42"W x 24"D Natural Recon laminate and edge, Silver paint	68	5.2	\$535
HLCRPL4224WFH-US.LNR1NR.PJW	42"W x 24"D Natural Recon laminate and edge, Designer White paint	68	5.2	\$535
HLCRPL4224WFH-US.LNR1NR.P71	42"W x 24"D Natural Recon laminate and edge, Black paint	68	5.2	\$535
HLCRPL4224WFH-US.LFW1FW.PR6	42"W x 24"D Florence Walnut laminate and edge, Silver paint	68	5.2	\$535
HLCRPL4224WFH-US.LFW1FW.PJW	42"W x 24"D Florence Walnut laminate and edge, Designer White paint	68	5.2	\$535
HLCRPL4224WFH-US.LFW1FW.P71	42"W x 24"D Florence Walnut laminate and edge, Black paint	68	5.2	\$535
HLCRPL4224WFH-US.LDW1DW.PR6	42"W x 24"D Designer White laminate and edge, Silver paint	68	5.2	\$535
HLCRPL4224WFH-US.LDW1DW.PJW	42"W x 24"D Designer White laminate and edge, Designer White paint	68	5.2	\$535
HLCRPL4224WFH-US.LDW1DW.P71	42"W x 24"D Designer White laminate and edge, Black paint	68	5.2	\$535

NOTES: Product ships with desk top and 4 legs in 2 cartons.



WORKSURFACES

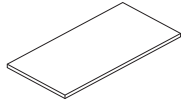

MODEL	DESCRIPTION	SHIP WEIGHT	CUBE	LIST PRICE
	Rectangular Worksurface			
HLCR2454WFH.LDWIDW	54"W x 24"D Designer White laminate and edge	45 Ⓢ	2.7	\$300
HLCR2454WFH.LFWIFW	54"W x 24"D Florence Walnut laminate and edge	45 Ⓢ	2.7	\$300
HLCR2454WFH.LNR1NR	54"W x 24"D Natural Recon laminate and edge	45 Ⓢ	2.7	\$300
HLCR2448WFH.LDWIDW	48"W x 24"D Designer White laminate and edge	40 Ⓢ	2.4	\$275
HLCR2448WFH.LFWIFW	48"W x 24"D Florence Walnut laminate and edge	40 Ⓢ	2.4	\$275
HLCR2448WFH.LNR1NR	48"W x 24"D Natural Recon laminate and edge	40 Ⓢ	2.4	\$275
HLCR2442WFH.LDWIDW	42"W x 24"D Designer White laminate and edge	35 Ⓢ	2.1	\$250
HLCR2442WFH.LFWIFW	42"W x 24"D Florence Walnut laminate and edge	35 Ⓢ	2.1	\$250
HLCR2442WFH.LNR1NR	42"W x 24"D Natural Recon laminate and edge	35 Ⓢ	2.1	\$250

NOTES: Compatible with Coordinate™ Height Adjustable Base model HHABETA2S2L with pre-drilled pilot holes. Worksurfaces come with threaded inserts for ease of installation with Post Legs models HLCPL29WFH and HLCPL29WFH-US.

NOTES:

- HON 5-Year Limited Warranty.

LEG AND STORAGE PACKS

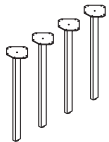

MODEL	DESCRIPTION		CUBE	LIST PRICE
	Post Legs			
HLCPL29WFH.P71	Pack of 4, Black finish	26 Ⓢ	3.0	\$230
HLCPL29WFH.PJW	Pack of 4, Designer White finish	26 Ⓢ	3.0	\$230
HLCPL29WFH.PR6	Pack of 4, Silver finish	26 Ⓢ	3.0	\$230

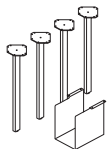

	Post Legs with U-Storage			
HLCPL29WFH-US.P71	Pack of 4 Legs, Black finish	33 Ⓢ	3.0	\$285
HLCPL29WFH-US.PJW	Pack of 4 Legs, Designer White finish	33 Ⓢ	3.0	\$285
HLCPL29WFH-US.PR6	Pack of 4 Legs, Silver finish	33 Ⓢ	3.0	\$285

NOTES: Metal storage ships same color as legs.

NOTES:

- HON 5-Year Limited Warranty.

MOD Typicals

Order components individually. Other configurations are possible, including various sizes of some components.

QTY	DESCRIPTION	MODEL	LIST PRICE	PRICE EXTENSION
1	Desk Shell 66"W x 30"D	HLPLDS6630	\$279	\$279
1	Credenza Shell 66"W x 24"D	HLPLCS6624	\$260	\$260
1	Bridge 42"W x 24"D	HLPLB4224	\$159	\$159
1	Pedestal - B/B/F 15"W x 20"D x 28"H	HLPLPSBBF	\$311	\$311
1	Pedestal - F/F 15"W x 20"D x 28"H	HLPLPSFF	\$311	\$311
1	Hutch without Doors 66"W x 14"D x 39¾"H	HLPLDH66	\$301	\$301
2	Laminate Hutch Doors Pack of 2 Doors	HLPLDR66LM	\$36	\$72
TOTAL:			\$1,693	

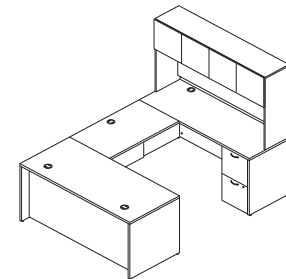

U-STATION (NON-HANDED)
66"W x 96"D

QTY	DESCRIPTION	MODEL	LIST PRICE	PRICE EXTENSION
1	Peninsula 66"W x 30"D	HLPLPEN6630	\$288	\$288
1	Credenza Shell 66"W x 24"D	HLPLCS6624	\$260	\$260
1	Bridge 42"W x 24"D	HLPLB4224	\$159	\$159
1	Pedestal - B/B/F 15"W x 20"D x 28"H	HLPLPSBBF	\$311	\$311
1	Hutch without Doors 66"W x 14"D x 39¾"H	HLPLDH66	\$301	\$301
1	Laminate Hutch Doors Pack of 2 Doors	HLPLDR66LM	\$36	\$36
TOTAL:			\$1,355	

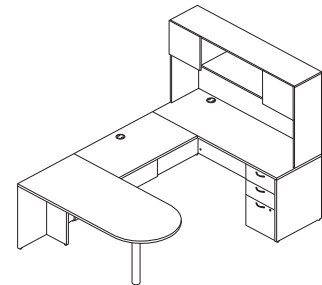

**U-STATION WITH PENINSULA
(NON-HANDED)**
66"W x 96"D

QTY	DESCRIPTION	MODEL	LIST PRICE	PRICE EXTENSION
1	Desk Shell 66"W x 30"D	HLPLDS6630	\$279	\$279
1	Return Shell 42"W x 24"D	HLPLRS4224	\$189	\$189
1	Pedestal - B/B/F 15"W x 20"D x 28"H	HLPLPSBBF	\$311	\$311
1	Pedestal - F/F 15"W x 20"D x 28"H	HLPLPSFF	\$311	\$311
1	Hutch without Doors 66"W x 14"D x 39¾"H	HLPLDH66	\$301	\$301
2	Glass Hutch Doors Pack of 2 Doors	HLPLDR66GS	\$131	\$262
TOTAL:			\$1,653	

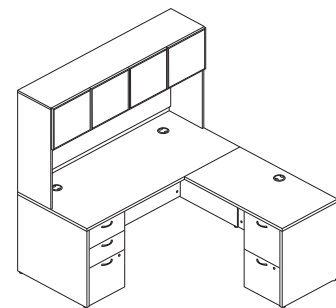

L-STATION (NON-HANDED)
66"W x 72"D

Order components individually. Other configurations are possible, including various sizes of some components.

QTY	DESCRIPTION	MODEL	LIST PRICE	PRICE EXTENSION
1	Bow Front Desk Shell 72"W x 36"D	HLPLDS7236B	\$353	\$353
1	Credenza Shell 72"W x 24"D	HLPLCS7224	\$270	\$270
1	Pedestal - B/B/F 15"W x 20"D x 28"H	HLPLPSBBF	\$311	\$311
1	Pedestal - F/F 15"W x 20"D x 28"H	HLPLPSFF	\$311	\$311
1	Hutch without Doors 66"W x 14"D x 39¾"H	HLPLDH66	\$301	\$301
2	Laminate Hutch Doors Pack of 2 Doors	HLPLDR66LM	\$36	\$72
TOTAL:			\$1,618	

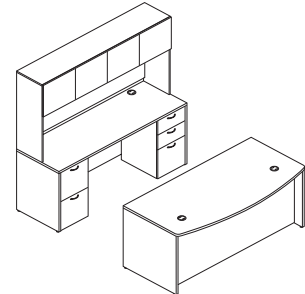

OFFICE SUITE
72"W x 96"D

QTY	DESCRIPTION	MODEL	LIST PRICE	PRICE EXTENSION
1	Reception Desk Shell 72"W x 30"D	HLPLRCPNDS7230	\$406	\$406
1	Reception Return Shell 42"W x 25"D	HLPLRCPNRS4225	\$245	\$245
1	Reception Laminate Transaction Top 72"W x 12"D	HLPLRCPNTPLM	\$86	\$86
1	Pedestal - B/B/F 15"W x 20"D x 28"H	HLPLPSBBF	\$311	\$311
TOTAL:			\$1,048	

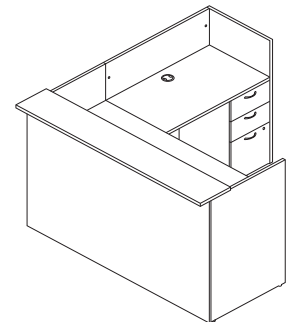

**RECEPTION STATION
(NON-HANDED)**
72"W x 72"D

QTY	DESCRIPTION	MODEL	LIST PRICE	PRICE EXTENSION
1	Rectangle Conference Table Top 48"W x 120"L, 2-Piece	HLPLTBL4812ORCT	\$658	\$658
1	Conference Table Base For 120" Table Tops	HLPLTBL120BASE	\$105	\$105
2	Wardrobe 24"W x 24"D x 65"H	HLPLW2424	\$796	\$1,592
2	Low Open Storage Credenza 36"W x 20"D x 21"H	HLPLCL3620S	\$243	\$486
1	Low Credenza Top 72"W x 20"D	HLPLCL7220TOP	\$127	\$127
TOTAL:			\$2,968	

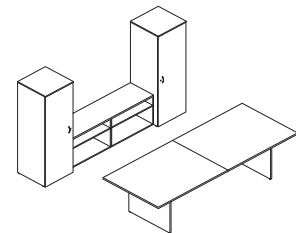

CONFERENCE ROOM
144"W x 180"D

MOD Typicals

Order components individually. Other configurations are possible, including various sizes of some components.

QTY	DESCRIPTION	MODEL	LIST PRICE	PRICE EXTENSION
1	Rectangle Worksurface 66"W x 30"D	HLPLRW6630	\$179	\$179
1	Rectangle Worksurface 48"W x 24"D	HLPLRW4824	\$135	\$135
1	Flat Bracket 24"D	HLPLFB24	\$45	\$45
2	U-Leg Support 30"W	HLPLLEG30U	\$144	\$288
1	U-Leg Support 24"W	HLPLLEG24U	\$135	\$135
1	External Stiffener For 66"W Worksurfaces	HLPLXS66	\$70	\$70
1	Mobile Pedestal – B/F 15"W x 20"D x 20"H	HLPLPMBF	\$272	\$272
1	Pedestal Cushion 15"W x 20"D	HLPLPSEAT1520	\$86	\$86

TOTAL: \$1,210

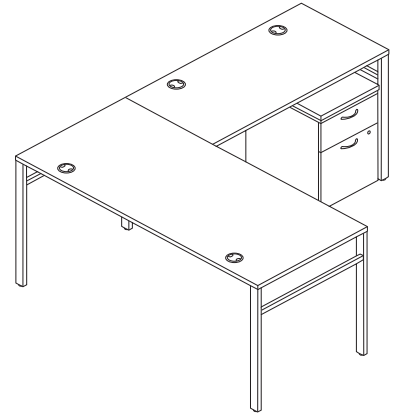

L-STATION (NON-HANDED)
66"W x 78"D

QTY	DESCRIPTION	MODEL	LIST PRICE	PRICE EXTENSION
1	Rectangle Worksurface 66"W x 30"D	HLPLRW6630	\$179	\$179
1	U-Leg Support 30"W	HLPLLEG30U	\$144	\$144
1	External Stiffener For 66"W Worksurfaces	HLPLXS66	\$70	\$70
1	Credenza Leg Support 7"H x 30"D	HLPLSL30	\$94	\$94
1	Low 2-Drawer Credenza 30"W x 20"D x 21"H	HLPLCL3020BF	\$505	\$505
1	Low Open Storage Credenza 30"W x 20"D x 21"H	HLPLCL3020S	\$232	\$232
1	Low Credenza Top 60"W x 20"D	HLPLCL6020TOP	\$116	\$116

TOTAL: \$1,340

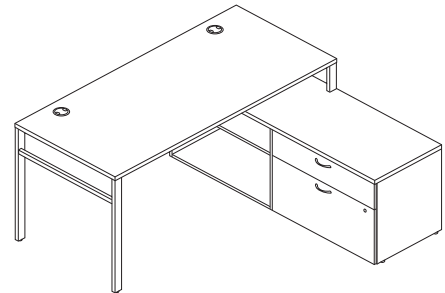

**L-STATION WITH CREDENZA
(NON-HANDED)**
66"W x 60"D



LAMINATE DESK SHELLS

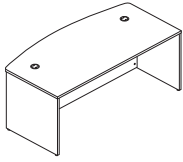

MODEL	DESCRIPTION	SHIP WEIGHT	CUBE	LIST PRICE
HLPLDS7236B.LSL1	Bow Front Desk Shell 72"W x 36"D / 30"D x 29"H, Bow Top Slate Teak laminate	149	6.6	\$353
HLPLDS7236B.LTM1	72"W x 36"D / 30"D x 29"H, Bow Top Traditional Mahogany laminate	149	6.6	\$353
HLPLDS7236B.LRC1	72"W x 36"D / 30"D x 29"H, Bow Top Russet Cherry laminate	149	6.6	\$353
HLPLDS7236B.LJA1	72"W x 36"D / 30"D x 29"H, Bow Top Java Oak laminate	149	6.6	\$353
HLPLDS7236B.LSE1	72"W x 36"D / 30"D x 29"H, Bow Top Sepia Walnut laminate	149	6.6	\$353

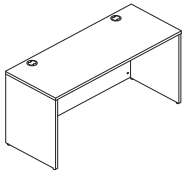

MODEL	DESCRIPTION	SHIP WEIGHT	CUBE	LIST PRICE
HLPLDS7236.LSL1	Rectangle Desk Shell 72"W x 36"D x 29"H, Rectangle Top Slate Teak laminate	149	6.6	\$300
HLPLDS7236.LTM1	72"W x 36"D x 29"H, Rectangle Top Traditional Mahogany laminate	149	6.6	\$300
HLPLDS7236.LRC1	72"W x 36"D x 29"H, Rectangle Top Russet Cherry laminate	149	6.6	\$300
HLPLDS7236.LJA1	72"W x 36"D x 29"H, Rectangle Top Java Oak laminate	149	6.6	\$300
HLPLDS7236.LSE1	72"W x 36"D x 29"H, Rectangle Top Sepia Walnut laminate	149	6.6	\$300
HLPLDS7230.LSL1	72"W x 30"D x 29"H, Rectangle Top Slate Teak laminate	149	5.6	\$295
HLPLDS7230.LTM1	72"W x 30"D x 29"H, Rectangle Top Traditional Mahogany laminate	149	5.6	\$295
HLPLDS7230.LRC1	72"W x 30"D x 29"H, Rectangle Top Russet Cherry laminate	149	5.6	\$295
HLPLDS7230.LJA1	72"W x 30"D x 29"H, Rectangle Top Java Oak laminate	149	5.6	\$295
HLPLDS7230.LSE1	72"W x 30"D x 29"H, Rectangle Top Sepia Walnut laminate	149	5.6	\$295
HLPLDS6630.LSL1	66"W x 30"D x 29"H, Rectangle Top Slate Teak laminate	116	5.1	\$279
HLPLDS6630.LTM1	66"W x 30"D x 29"H, Rectangle Top Traditional Mahogany laminate	116	5.1	\$279
HLPLDS6630.LRC1	66"W x 30"D x 29"H, Rectangle Top Russet Cherry laminate	116	5.1	\$279
HLPLDS6630.LJA1	60"W x 30"D x 29"H, Rectangle Top Java Oak laminate	116	5.1	\$279
HLPLDS6630.LSE1	66"W x 30"D x 29"H, Rectangle Top Sepia Walnut laminate	116	5.1	\$279

NOTES:

- Scratch- and stain-resistant thermal-fused laminate surfaces.
- Durable 1" thick tops and end panels.
- Full height modesty panels.
- Desk, Credenza, Return Shells, and Bridge assemble quickly and easily.
- Desks, Credenzas, Return Shells, and Bridges come standard with 3" round Black grommets.
- Adjustable floor leveling glides provide 3/4" of adjustment.
- **HON 5-Year Limited Warranty.**



LAMINATE DESK SHELLS

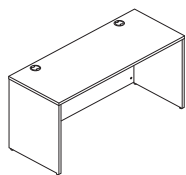

MODEL	DESCRIPTION	SHIP WEIGHT	CUBE	LIST PRICE
	Rectangle Desk Shell			
HLPLDS6030.LSL1	60"W x 30"D x 29"H, Rectangle Top Slate Teak laminate	111	4.7	\$255
HLPLDS6030.LTM1	60"W x 36"D x 29"H, Rectangle Top Traditional Mahogany laminate	111	4.7	\$255
HLPLDS6030.LRC1	60"W x 30"D x 29"H, Rectangle Top Russet Cherry laminate	111	4.7	\$255
HLPLDS6030.LJA1	60"W x 30"D x 29"H, Rectangle Top Java Oak laminate	111	4.7	\$255
HLPLDS6030.LSE1	60"W x 30"D x 29"H, Rectangle Top Sepia Walnut laminate	111	4.7	\$255
HLPLDS4830.LSL1	48"W x 30"D x 29"H, Rectangle Top Slate Teak laminate	75	4.7	\$245
HLPLDS4830.LTM1	48"W x 36"D x 29"H, Rectangle Top Traditional Mahogany laminate	75	4.7	\$245
HLPLDS4830.LRC1	48"W x 30"D x 29"H, Rectangle Top Russet Cherry laminate	75	4.7	\$245
HLPLDS4830.LJA1	48"W x 30"D x 29"H, Rectangle Top Java Oak laminate	75	4.7	\$245
HLPLDS4830.LSE1	48"W x 30"D x 29"H, Rectangle Top Sepia Walnut laminate	75	4.7	\$245

LAMINATE CREDENZA SHELLS

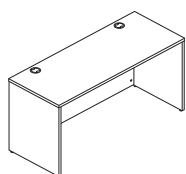

MODEL	DESCRIPTION	SHIP WEIGHT	CUBE	LIST PRICE
	Credenza Shell			
HLPLCS7224.LSL1	72"W x 24"D x 29"H Slate Teak laminate	108	5.3	\$270
HLPLCS7224.LTM1	72"W x 24"D x 29"H Traditional Mahogany laminate	108	5.3	\$270
HLPLCS7224.LRC1	72"W x 24"D x 29"H Russet Cherry laminate	108	5.3	\$270
HLPLCS7224.LJA1	72"W x 24"D x 29"H Java Oak laminate	108	5.3	\$270
HLPLCS7224.LSE1	72"W x 24"D x 29"H Sepia Walnut laminate	108	5.3	\$270

NOTES:

- Scratch- and stain-resistant thermal-fused laminate surfaces.
- Durable 1" thick tops and end panels.
- Full height modesty panels.
- Desk, Credenza, Return Shells, and Bridge assemble quickly and easily.
- Desks, Credenzas, Return Shells, and Bridges come standard with 3" round Black grommets.
- Adjustable floor leveling glides provide 3/4" of adjustment.
- **HON 5-Year Limited Warranty.**



LAMINATE CREDENZA SHELLS

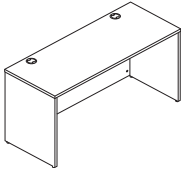

MODEL	DESCRIPTION	SHIP WEIGHT	CUBE	LIST PRICE
	Credenza Shell			
HLPLCS6624.LSL1	66"W x 24"D x 29"H Slate Teak laminate	96	4.8	\$260
HLPLCS6624.LTM1	66"W x 24"D x 29"H Traditional Mahogany laminate	96	4.8	\$260
HLPLCS6624.LRC1	66"W x 24"D x 29"H Russet Cherry laminate	96	4.8	\$260
HLPLCS6624.LJA1	66"W x 24"D x 29"H Java Oak laminate	96	4.8	\$260
HLPLCS6624.LSE1	66"W x 24"D x 29"H Sepia Walnut laminate	96	4.8	\$260
HLPLCS6024.LSL1	60"W x 24"D x 29"H Slate Teak laminate	96	4.4	\$240
HLPLCS6024.LTM1	60"W x 24"D x 29"H Traditional Mahogany laminate	96	4.4	\$240
HLPLCS6024.LRC1	60"W x 24"D x 29"H Russet Cherry laminate	96	4.4	\$240
HLPLCS6024.LJA1	60"W x 24"D x 29"H Java Oak laminate	96	4.4	\$240
HLPLCS6024.LSE1	60"W x 24"D x 29"H Sepia Walnut laminate	96	4.4	\$240
HLPLCS4824.LSL1	48"W x 24"D x 29"H Slate Teak laminate	75	3.7	\$235
HLPLCS4824.LTM1	48"W x 24"D x 29"H Traditional Mahogany laminate	75	3.7	\$235
HLPLCS4824.LRC1	48"W x 24"D x 29"H Russet Cherry laminate	75	3.7	\$235
HLPLCS4824.LJA1	48"W x 24"D x 29"H Java Oak laminate	75	3.7	\$235
HLPLCS4824.LSE1	48"W x 24"D x 29"H Sepia Walnut laminate	75	3.7	\$235

NOTES:

- Scratch- and stain-resistant thermal-fused laminate surfaces.
- Durable 1" thick tops and end panels.
- Full height modesty panels.
- Desk, Credenza, Return Shells, and Bridge assemble quickly and easily.
- Desks, Credenzas, Return Shells, and Bridges come standard with 3" round Black grommets.
- Adjustable floor leveling glides provide 3/4" of adjustment.
- **HON 5-Year Limited Warranty.**



LAMINATE RETURN SHELLS

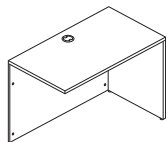

MODEL	DESCRIPTION	SHIP WEIGHT	CUBE	LIST PRICE
	Return Shell			
HLPLRS4824.LSL1	48"W x 24"D x 29"H Slate Teak laminate	66	4.2	\$198
HLPLRS4824.LTM1	48"W x 24"D x 29"H Traditional Mahogany laminate	66	4.2	\$198
HLPLRS4824.LRC1	48"W x 24"D x 29"H Russet Cherry laminate	66	4.2	\$198
HLPLRS4824.LJA1	48"W x 24"D x 29"H Java Oak laminate	66	4.2	\$198
HLPLRS4824.LSE1	48"W x 24"D x 29"H Sepia Walnut laminate	66	4.2	\$198
HLPLRS4224.LSL1	42"W x 24"D x 29"H Slate Teak laminate	60	4.4	\$189
HLPLRS4224.LTM1	42"W x 24"D x 29"H Traditional Mahogany laminate	60	4.4	\$189
HLPLRS4224.LRC1	42"W x 24"D x 29"H Russet Cherry laminate	60	4.4	\$189
HLPLRS4224.LJA1	42"W x 24"D x 29"H Java Oak laminate	60	4.4	\$189
HLPLRS4224.LSE1	42"W x 24"D x 29"H Sepia Walnut laminate	60	4.4	\$189
HLPLRS3624.LSL1	36"W x 24"D x 29"H Slate Teak laminate	54	2.8	\$157
HLPLRS3624.LTM1	36"W x 24"D x 29"H Traditional Mahogany laminate	54	2.8	\$157
HLPLRS3624.LRC1	36"W x 24"D x 29"H Russet Cherry laminate	54	2.8	\$157
HLPLRS3624.LJA1	36"W x 24"D x 29"H Java Oak laminate	54	2.8	\$157
HLPLRS3624.LSE1	36"W x 24"D x 29"H Sepia Walnut laminate	54	2.8	\$157

NOTES:

- Scratch- and stain-resistant thermal-fused laminate surfaces.
- Durable 1" thick tops and end panels.
- Full height modesty panels.
- Desk, Credenza, Return Shells, and Bridge assemble quickly and easily.
- Desks, Credenzas, Return Shells, and Bridges come standard with 3" round Black grommets.
- Adjustable floor leveling glides provide 3/4" of adjustment.
- **HON 5-Year Limited Warranty.**



LAMINATE BRIDGES

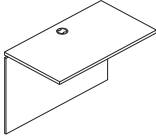

MODEL	DESCRIPTION	SHIP WEIGHT	CUBE	LIST PRICE
	Bridge			
HLPLB4824.LSL1	48"W x 24"D x 29"H Slate Teak laminate	53	4.2	\$161
HLPLB4824.LTM1	48"W x 24"D x 29"H Traditional Mahogany laminate	53	4.2	\$161
HLPLB4824.LRC1	48"W x 24"D x 29"H Russet Cherry laminate	53	4.2	\$161
HLPLB4824.LJA1	48"W x 24"D x 29"H Java Oak laminate	53	4.2	\$161
HLPLB4824.LSE1	48"W x 24"D x 29"H Sepia Walnut laminate	53	4.2	\$161
HLPLB4224.LSL1	42"W x 24"D x 29"H Slate Teak laminate	46	4.2	\$159
HLPLB4224.LTM1	42"W x 24"D x 29"H Traditional Mahogany laminate	46	4.2	\$159
HLPLB4224.LRC1	42"W x 24"D x 29"H Russet Cherry laminate	46	4.2	\$159
HLPLB4224.LJA1	42"W x 24"D x 29"H Java Oak laminate	42	4.2	\$159
HLPLB4224.LSE1	42"W x 24"D x 29"H Sepia Walnut laminate	42	4.2	\$159
HLPLB3624.LSL1	36"W x 24"D x 29"H Slate Teak laminate	40	3.7	\$133
HLPLB3624.LTM1	36"W x 24"D x 29"H Traditional Mahogany laminate	40	3.7	\$133
HLPLB3624.LRC1	36"W x 24"D x 29"H Russet Cherry laminate	40	3.7	\$133
HLPLB3624.LJA1	36"W x 24"D x 29"H Java Oak laminate	40	3.7	\$133
HLPLB3624.LSE1	36"W x 24"D x 29"H Sepia Walnut laminate	40	3.7	\$133

NOTES:

- Scratch- and stain-resistant thermal-fused laminate surfaces.
- Durable 1" thick tops and end panels.
- Full height modesty panels.
- Desk, Credenza, Return Shells, and Bridge assemble quickly and easily.
- Desks, Credenzas, Return Shells, and Bridges come standard with 3" round Black grommets.
- Adjustable floor leveling glides provide 3/4" of adjustment.
- **HON 5-Year Limited Warranty.**



LAMINATE CORNER SHELLS

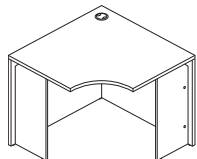

MODEL	DESCRIPTION	SHIP WEIGHT	CUBE	LIST PRICE
	Corner Shell			
HLPLCS36.LSL1	36"W x 24"D x 29"H Slate Teak laminate	114	5.3	\$254
HLPLCS36.LTM1	36"W x 24"D x 29"H Traditional Mahogany laminate	114	5.3	\$254
HLPLCS36.LRC1	36"W x 24"D x 29"H Russet Cherry laminate	114	5.3	\$254
HLPLCS36.LJA1	36"W x 24"D x 29"H Java Oak laminate	114	5.3	\$254
HLPLCS36.LSE1	36"W x 24"D x 29"H Sepia Walnut laminate	114	5.3	\$254
HLPLCS30.LSL1	30"W x 24"D x 29"H Slate Teak laminate	93	3.2	\$229
HLPLCS30.LTM1	30"W x 24"D x 29"H Traditional Mahogany laminate	93	3.2	\$229
HLPLCS30.LRC1	30"W x 24"D x 29"H Russet Cherry laminate	93	3.2	\$229
HLPLCS30.LJA1	30"W x 24"D x 29"H Java Oak laminate	93	3.2	\$229
HLPLCS30.LSE1	30"W x 24"D x 29"H Sepia Walnut laminate	93	3.2	\$229

LAMINATE PENINSULAS WITH END PANEL

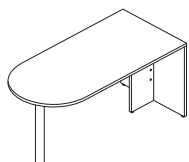

MODEL	DESCRIPTION	SHIP WEIGHT	CUBE	LIST PRICE
	Peninsula w/End Panel			
HLPLPEN7236.LSL1.BLKP	72"W 36"D x 29"H Slate Teak laminate, Black paint	116	14.6	\$325
HLPLPEN7236.LTM1.BLKP	72"W x 36"D x 29"H Traditional Mahogany laminate, Black paint	116	14.6	\$325
HLPLPEN7236.LRC1.BLKP	72"W x 36"D x 29"H Russet Cherry laminate, Black paint	116	14.6	\$325
HLPLPEN7236.LJA1.BLKP	72"W x 36"D x 29"H Java Oak laminate, Black paint	116	14.6	\$325
HLPLPEN7236.LSE1.BLKP	72"W x 36"D x 29"H Sepia Walnut laminate, Black paint	116	14.6	\$325
HLPLPEN6630.LSL1.BLKP	66"W x 24"D x 29"H Slate Teak laminate, Black paint	91	11.4	\$288
HLPLPEN6630.LTM1.BLKP	66"W x 24"D x 29"H Traditional Mahogany laminate, Black paint	91	11.4	\$288
HLPLPEN6630.LRC1.BLKP	66"W x 24"D x 29"H Russet Cherry laminate, Black paint	91	11.4	\$288
HLPLPEN6630.LJA1.BLKP	66"W x 24"D x 29"H Java Oak laminate, Black paint	91	11.4	\$288
HLPLPEN6630.LSE1.BLKP	66"W x 24"D x 29"H Sepia Walnut laminate, Black paint	91	11.4	\$288

NOTES:

- Scratch- and stain-resistant thermal-fused laminate surfaces.
- Durable 1" thick tops and end panels.
- Full height modesty panels.
- Corner Shells and Peninsula assemble quickly and easily.
- Corner Shells come standard with 3" round Black grommets.
- Adjustable floor leveling glides provide 3/4" of adjustment.
- **HON 5-Year Limited Warranty.**



LAMINATE HUTCHES

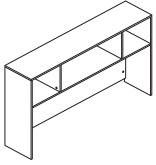

MODEL	DESCRIPTION	SHIP WEIGHT	CUBE	LIST PRICE
	Hutch without Doors			
HLPLDH72.LSL1	72"W x 14"D x 39¾"H Slate Teak laminate	106	7.1	\$316
HLPLDH72.LTM1	72"W x 14"D x 39¾"H Traditional Mahogany laminate	106	7.1	\$316
HLPLDH72.LRC1	72"W x 14"D x 39¾"H Russet Cherry laminate	106	7.1	\$316
HLPLDH72.LJA1	72"W x 14"D x 39¾"H Java Oak laminate	106	7.1	\$316
HLPLDH72.LSE1	72"W x 14"D x 39¾"H Sepia Walnut laminate	106	7.1	\$316
HLPLDH66.LSL1	66"W x 14"D x 39¾"H Slate Teak laminate	99	7.2	\$301
HLPLDH66.LTM1	66"W x 14"D x 39¾"H Traditional Mahogany laminate	99	7.2	\$301
HLPLDH66.LRC1	66"W x 14"D x 39¾"H Russet Cherry laminate	99	7.2	\$301
HLPLDH66.LJA1	66"W x 14"D x 39¾"H Java Oak laminate	99	7.2	\$301
HLPLDH66.LSE1	66"W x 14"D x 39¾"H Sepia Walnut laminate	99	7.2	\$301
HLPLDH60.LSL1	60"W x 14"D x 39¾"H Slate Teak laminate	92	5.3	\$293
HLPLDH60.LTM1	60"W x 14"D x 39¾"H Traditional Mahogany laminate	92	5.3	\$293
HLPLDH60.LRC1	60"W x 14"D x 39¾"H Russet Cherry laminate	92	5.3	\$293
HLPLDH60.LJA1	60"W x 14"D x 39¾"H Java Oak laminate	92	5.3	\$293
HLPLDH60.LSE1	60"W x 14"D x 39¾"H Sepia Walnut laminate	92	5.3	\$293

NOTES:

- Scratch- and stain-resistant thermal-fused laminate surfaces.
- Full back with gap at bottom for wire management.
- Durable 5/8" thick tops and end panels.
- 72"W, 66"W, and 60"W hutches include fully enclosed back.
- Hutches and Wall Mounted Storage assemble quickly and easily.
- **HON 5-Year Limited Warranty.**

① Hutch and Wall Mounted Storage units are sold without doors. 2 Doors or 4 Doors can be added to 72"W, 66"W, and 60"W units. 48"W Wall Mounted Storage Doors are sold in packages of 3 only.



LAMINATE WALL MOUNTED STORAGE

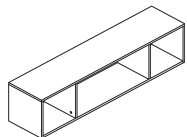

MODEL	DESCRIPTION	WEIGHT	CUBE	LIST PRICE
	Wall Mounted Storage without Doors			
HLPLWMH72.LSL1	72"W x 14"D x 13½"H Slate Teak laminate	66	3.1	\$376
HLPLWMH72.LTM1	72"W x 14"D x 13½"H Traditional Mahogany laminate	66	3.1	\$376
HLPLWMH72.LRC1	72"W x 14"D x 13½"H Russet Cherry laminate	66	3.1	\$376
HLPLWMH72.LJA1	72"W x 14"D x 13½"H Java Oak laminate	66	3.1	\$376
HLPLWMH72.LSE1	72"W x 14"D x 13½"H Sepia Walnut laminate	66	3.1	\$376
HLPLWMH72.LPW1	72"W x 14"D x 13½"H Simply White laminate	66	3.1	\$376
HLPLWMH66.LSL1	66"W x 14"D x 13½"H Slate Teak laminate	62	3.6	\$361
HLPLWMH66.LTM1	66"W x 14"D x 13½"H Traditional Mahogany laminate	62	3.6	\$361
HLPLWMH66.LRC1	66"W x 14"D x 13½"H Russet Cherry laminate	62	3.6	\$361
HLPLWMH66.LJA1	66"W x 14"D x 13½"H Java Oak laminate	62	3.6	\$361
HLPLWMH66.LSE1	66"W x 14"D x 13½"H Sepia Walnut laminate	62	3.6	\$361
HLPLWMH66.LPW1	66"W x 14"D x 13½"H Simply White laminate	62	3.6	\$361
HLPLWMH60.LSL1	60"W x 14"D x 13½"H Slate Teak laminate	57	3.0	\$353
HLPLWMH60.LTM1	60"W x 14"D x 13½"H Traditional Mahogany laminate	57	3.0	\$353
HLPLWMH60.LRC1	60"W x 14"D x 13½"H Russet Cherry laminate	57	3.0	\$353
HLPLWMH60.LJA1	60"W x 14"D x 13½"H Java Oak laminate	57	3.0	\$353
HLPLWMH60.LSE1	60"W x 14"D x 13½"H Sepia Walnut laminate	57	3.0	\$353
HLPLWMH60.LPW1	60"W x 14"D x 13½"H Simply White laminate	57	3.0	\$353
HLPLWMH48.LSL1	48"W x 14"D x 13½"H Slate Teak laminate	48	2.5	\$338
HLPLWMH48.LTM1	48"W x 14"D x 13½"H Traditional Mahogany laminate	48	2.5	\$338
HLPLWMH48.LRC1	48"W x 14"D x 13½"H Russet Cherry laminate	48	2.5	\$338
HLPLMH48.LJA1	48"W x 14"D x 13½"H Java Oak laminate	48	2.5	\$338
HLPLWMH48.LSE1	48"W x 14"D x 13½"H Sepia Walnut laminate	48	2.5	\$338
HLPLWMH48.LPW1	48"W x 14"D x 13½"H Simply White laminate	48	2.5	\$338

NOTES:

- Scratch- and stain-resistant thermal-fused laminate surfaces.
- Durable 5/8" thick tops and end panels.
- 72"W, 66"W, and 60"W hutches include fully enclosed back.
- Hutches and Wall Mounted Storage assemble quickly and easily.
- **HON 5-Year Limited Warranty.**

❗ Hutch and Wall Mounted Storage units are sold without doors. 2 Doors or 4 Doors can be added to 72"W, 66"W, and 60"W units. 48"W Wall Mounted Storage Doors are sold in packages of 3 only.



LAMINATE AND GLASS HUTCH DOORS

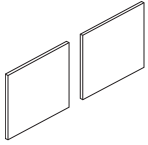

MODEL	DESCRIPTION	SHIP WEIGHT	CUBE	LIST PRICE
Laminate Doors for Hutch and Wall Mounted Storage				
	2 Pack, for HLPLDH72 and HLPLWMH72			
HLPLDR72LM.LSL1	Slate Teak laminate	12	0.8	\$36
HLPLDR72LM.LTM1	Traditional Mahogany laminate	12	0.8	\$36
HLPLDR72LM.LRC1	Russet Cherry laminate	12	0.8	\$36
HLPLDR72LM.LJA1	Java Oak laminate	12	0.8	\$36
HLPLDR72LM.LSE1	Sepia Walnut laminate	12	0.8	\$36
HLPLDR72LM.LPW1	Simply White laminate	12	0.8	\$36
	2 Pack, for HLPLDH66 and HLPLWMH66			
HLPLDR66LM.LSL1	Slate Teak laminate	12	0.8	\$36
HLPLDR66LM.LTM1	Traditional Mahogany laminate	12	0.8	\$36
HLPLDR66LM.LRC1	Russet Cherry laminate	12	0.8	\$36
HLPLDR66LM.LJA1	Java Oak laminate	12	0.8	\$36
HLPLDR66LM.LSE1	Sepia Walnut laminate	12	0.8	\$36
HLPLDR66LM.LPW1	Simply White laminate	12	0.8	\$36
	2 Pack, for HLPLDH60 and HLPLWMH60			
HLPLDR60LM.LSL1	Slate Teak laminate	12	0.8	\$36
HLPLDR60LM.LTM1	Traditional Mahogany laminate	12	0.8	\$36
HLPLDR60LM.LRC1	Russet Cherry laminate	12	0.8	\$36
HLPLDR60LM.LJA1	Java Oak laminate	12	0.8	\$36
HLPLDR60LM.LSE1	Sepia Walnut laminate	12	0.8	\$36
HLPLDR60LM.LPW1	Simply White laminate	12	0.8	\$36
	3 Pack, for HLPLDH48			
HLPLDR48LM.LSL1	Slate Teak laminate	17	0.8	\$54
HLPLDR48LM.LTM1	Traditional Mahogany laminate	17	0.8	\$54
HLPLDR48LM.LRC1	Russet Cherry laminate	17	0.8	\$54
HLPLDR48LM.LJA1	Java Oak laminate	17	0.8	\$54
HLPLDR48LM.LSE1	Sepia Walnut laminate	17	0.8	\$54
HLPLDR48LM.LPW1	Simply White laminate	17	0.8	\$54

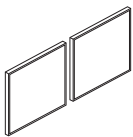

MODEL	DESCRIPTION	SHIP WEIGHT	CUBE	LIST PRICE
Glass Doors for Hutch and Wall Mounted Storage				
	2 Pack, for HLPLDH72 and HLPLWMH72			
HLPLDR72GS		9	0.8	\$131
	2 Pack, for HLPLDH66 and HLPLWMH66			
HLPLDR66GS		9	0.8	\$131
	2 Pack, for HLPLDH60 and HLPLWMH60			
HLPLDR60GS		9	0.8	\$131
	3 Pack, for HLPLWMH48			
HLPLDR48GS		13	0.8	\$198

NOTES:

- Scratch- and stain-resistant thermal-fused laminate surfaces.
- Durable 5/8" thick tops and end panels.
- 72"W, 66"W, and 60"W hutches include fully enclosed back.
- Hutches and Wall Mounted Storage assemble quickly and easily.
- **HON 5-Year Limited Warranty.**

! Hutch and Wall Mounted Storage units are sold without doors. 2 Doors or 4 Doors can be added to 72"W, 66"W, and 60"W units. 48"W Wall Mounted Storage Doors are sold in packages of 3 only.



TACKBOARDS

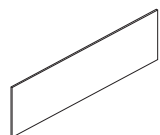

MODEL	DESCRIPTION	SHIP WEIGHT	CUBE	LIST PRICE
	Tackboards			
HLPLTACK72.CN02	72"W x 18"H Cool Neutral fabric	12	2.4	\$115
HLPLTACK72.WM01	72"W x 18"H Warm Neutral fabric	12	2.4	\$115
HLPLTACK66.CN02	66"W x 18"H Cool Neutral fabric	12	2.2	\$110
HLPLTACK66.WM01	66"W x 18"H Warm Neutral fabric	12	2.2	\$110
HLPLTACK60.CN02	60"W x 18"H Cool Neutral fabric	10	2.1	\$105
HLPLTACK60.WM01	60"W x 18"H Warm Neutral fabric	10	2.1	\$105
HLPLTACK48.CN02	48"W x 18"H Cool Neutral fabric	8	1.7	\$95
HLPLTACK48.WM01	48"W x 18"H Warm Neutral fabric	8	1.7	\$95

MARKERBOARD

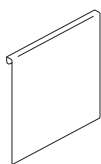

MODEL	DESCRIPTION	SHIP WEIGHT	CUBE	LIST PRICE
HLPLDR12MB	Markerboard 12"W x 12"H	3	0.6	\$65

NOTES:

- Scratch- and stain-resistant thermal-fused laminate surfaces.
- Durable 5/8" thick tops and end panels.
- 72"W, 66"W, and 60"W hutches include fully enclosed back.
- Hutches and Wall Mounted Storage assemble quickly and easily.
- **HON 5-Year Limited Warranty.**

❗ Hutch and Wall Mounted Storage units are sold without doors. 2 Doors or 4 Doors can be added to 72"W, 66"W, and 60"W units. 48"W Wall Mounted Storage Doors are sold in packages of 3 only.



LAMINATE SUPPORT PEDESTALS

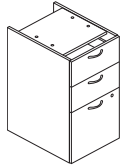

MODEL	DESCRIPTION	SHIP WEIGHT	CUBE	LIST PRICE
Corner Shell				
HLPLPSBBF.LSL1	15"W x 20"D x 28"H, Box/Box/File Slate Teak laminate	81.0	7.4	\$311
HLPLPSBBF.LTM1	15"W x 20"D x 28"H, Box/Box/File Traditional Mahogany laminate	81.0	7.4	\$311
HLPLPSBBF.LRC1	15"W x 20"D x 28"H, Box/Box/File Russet Cherry laminate	81.0	7.4	\$311
HLPLPSBBF.LJA1	15"W x 20"D x 28"H, Box/Box/File Java Oak laminate	81.0	7.4	\$311
HLPLPSBBF.LSE1	15"W x 20"D x 28"H, Box/Box/File Sepia Walnut laminate	81.0	7.4	\$311
HLPLPSBBF.LPW1	15"W x 20"D x 28"H, Box/Box/File Simply White laminate	81.0	7.4	\$311
File/File				
HLPLPSFF.LSL1	15"W x 20"D x 28"H, File/File Slate Teak laminate	79.0	7.4	\$311
HLPLPSFF.LTM1	15"W x 20"D x 28"H, File/File Traditional Mahogany laminate	79.0	7.4	\$311
HLPLPSFF.LRC1	15"W x 20"D x 28"H, File/File Russet Cherry laminate	79.0	7.4	\$311
HLPLPSFF.LJA1	15"W x 20"D x 28"H, File/File Java Oak laminate	79.0	7.4	\$311
HLPLPSFF.LSE1	15"W x 20"D x 28"H, File/File Sepia Walnut laminate	79.0	7.4	\$311
HLPLPSFF.LPW1	15"W x 20"D x 28"H, File/File Simply White laminate	79.0	7.4	\$311

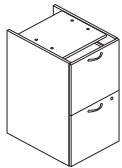

! Top is unfinished. Not to be used freestanding.

LAMINATE HANGING PEDESTALS

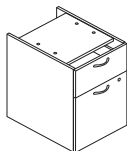

MODEL	DESCRIPTION	SHIP WEIGHT	CUBE	LIST PRICE
Hanging Pedestal				
HLPLPHBF.LSL1	15"W x 20"D x 20"H, Box/File Slate Teak laminate	63.0	5.8	\$228
HLPLPHBF.LTM1	15"W x 20"D x 20"H, Box/File Traditional Mahogany laminate	63.0	5.8	\$228
HLPLPHBF.LRC1	15"W x 20"D x 20"H, Box/File Russet Cherry laminate	63.0	5.8	\$228
HLPLPHBF.LJA1	15"W x 20"D x 20"H, Box/File Java Oak laminate	63.0	5.8	\$228
HLPLPHBF.LSE1	15"W x 20"D x 20"H, Box/File Sepia Walnut laminate	63.0	5.8	\$228
HLPLPHBF.LPW1	15"W x 20"D x 20"H, Box/File Simply White laminate	63.0	5.8	\$228

! Top is unfinished. Not to be used freestanding.

! Hanging Pedestal is designed to attach to the underside of the worksurface and is non-handed (can be assembled on left or right side).

NOTES:

- Pedestals ship assembled.
- Support Pedestals are designed to be used under a desk, credenza, or return shell.
- Drawers operate on full extension, ball-bearing suspensions to ensure smooth, quiet, and long-lasting operation.
- Pedestals come standard with Arch pull in Silver finish.
- **HON 5-Year Limited Warranty.**



LAMINATE MOBILE PEDESTALS

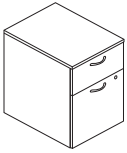

HLPLMBF shown

MODEL	DESCRIPTION	SHIP WEIGHT	CUBE	LIST PRICE
HLPLMBBF.LSL1	Mobile Pedestals 15"W x 20"D x 28"H, Box/Box/File Slate Teak laminate	81.0	7.4	\$383
HLPLMBBF.LTM1	15"W x 20"D x 28"H, Box/Box/File Traditional Mahogany laminate	81.0	7.4	\$383
HLPLMBBF.LRC1	15"W x 20"D x 28"H, Box/Box/File Russet Cherry laminate	81.0	7.4	\$383
HLPLMBBF.LJA1	15"W x 20"D x 28"H, Box/Box/File Java Oak laminate	81.0	7.4	\$383
HLPLMBBF.LSE1	15"W x 20"D x 28"H, Box/Box/File Sepia Walnut laminate	81.0	7.4	\$383
HLPLMBBF.LPW1	15"W x 20"D x 28"H, Box/Box/File Simply White laminate	81.0	7.4	\$383
HLPLPMFF.LSL1	15"W x 20"D x 28"H, File/File Slate Teak laminate	79.0	7.4	\$383
HLPLPMFF.LTM1	15"W x 20"D x 28"H, File/File Traditional Mahogany laminate	79.0	7.4	\$383
HLPLPMFF.LRC1	15"W x 20"D x 28"H, File/File Russet Cherry laminate	79.0	7.4	\$383
HLPLPMFF.LJA1	15"W x 20"D x 28"H, File/File Java Oak laminate	79.0	7.4	\$383
HLPLPMFF.LSE1	15"W x 20"D x 28"H, File/File Sepia Walnut laminate	79.0	7.4	\$383
HLPLPMFF.LPW1	15"W x 20"D x 28"H, File/File Simply White laminate	79.0	7.4	\$383
HLPLMBF.LSL1	15"W x 20"D x 20"H, Box/File Slate Teak laminate	63.0	5.8	\$272
HLPLMBF.LTM1	15"W x 20"D x 20"H, Box/File Traditional Mahogany laminate	63.0	5.8	\$272
HLPLMBF.LRC1	15"W x 20"D x 20"H, Box/File Russet Cherry laminate	63.0	5.8	\$272
HLPLMBF.LJA1	15"W x 20"D x 20"H, Box/File Java Oak laminate	63.0	5.8	\$272
HLPLMBF.LSE1	15"W x 20"D x 28"H, Box/Box/File Sepia Walnut laminate	63.0	5.8	\$272
HLPLMBF.LPW1	15"W x 20"D x 28"H, Box/Box/File Simply White laminate	63.0	5.8	\$272

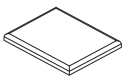

MODEL	DESCRIPTION	SHIP WEIGHT	CUBE	LIST PRICE
HLPLPSEAT1520.CN02	Pedestal Cushion 15"W x 20"D Cool Neutral fabric	6.0	1.1	\$86
HLPLPSEAT1520.WM01	15"W x 20"D Warm Neutral fabric	6.0	1.1	\$86

NOTES:

- Pedestals ship assembled.
- Drawers operate on full extension, ball-bearing suspensions to ensure smooth, quiet, and long-lasting operation.
- Pedestals come standard with Arch pull in Silver finish.
- **HON 5-Year Limited Warranty.**



LAMINATE BOOKCASES

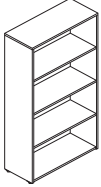

HLPLBC3013B5 shown

MODEL	DESCRIPTION	SHIP WEIGHT	CUBE	LIST PRICE
Bookcases				
HLPLBC3013B5.LSL1	30"W x 13"D x 65"H, 5-Shelf, 3 Adjustable Shelves, 1 Fixed Shelf Slate Teak laminate	137	6.1	\$306
HLPLBC3013B5.LTM1	30"W x 13"D x 65"H, 5-Shelf, 3 Adjustable Shelves, 1 Fixed Shelf Traditional Mahogany laminate	137	6.1	\$306
HLPLBC3013B5.LRC1	30"W x 13"D x 65"H, 5-Shelf, 3 Adjustable Shelves, 1 Fixed Shelf Russet Cherry laminate	137	6.1	\$306
HLPLBC3013B5.LJA1	30"W x 13"D x 65"H, 5-Shelf, 3 Adjustable Shelves, 1 Fixed Shelf Java Oak laminate	137	6.1	\$306
HLPLBC3013B5.LSE1	30"W x 13"D x 65"H, 5-Shelf, 3 Adjustable Shelves, 1 Fixed Shelf Sepia Walnut laminate	137	6.1	\$306
HLPLBC3013B4.LSL1	30"W x 13"D x 53"H, 4-Shelf, 2 Adjustable Shelves, 1 Fixed Shelf Slate Teak laminate	112	5.2	\$219
HLPLBC3013B4.LTM1	30"W x 13"D x 53"H, 4-Shelf, 2 Adjustable Shelves, 1 Fixed Shelf Traditional Mahogany laminate	112	5.2	\$219
HLPLBC3013B4.LRC1	30"W x 13"D x 53"H, 4-Shelf, 2 Adjustable Shelves, 1 Fixed Shelf Russet Cherry laminate	112	5.2	\$219
HLPLBC3013B4.LJA1	30"W x 13"D x 53"H, 4-Shelf, 2 Adjustable Shelves, 1 Fixed Shelf Java Oak laminate	112	5.2	\$219
HLPLBC3013B4.LSE1	30"W x 13"D x 53"H, 4-Shelf, 2 Adjustable Shelves, 1 Fixed Shelf Sepia Walnut laminate	112	5.2	\$219
HLPLBC3013B2.LSL1	30"W x 13"D x 29"H, 2-Shelf, 1 Fixed Shelf Slate Teak laminate	63	3.2	\$150
HLPLBC3013B2.LTM1	30"W x 13"D x 29"H, 2-Shelf, 1 Fixed Shelf Traditional Mahogany laminate	63	3.2	\$150
HLPLBC3013B2.LRC1	30"W x 13"D x 29"H, 2-Shelf, 1 Fixed Shelf Russet Cherry laminate	63	3.2	\$150
HLPLBC3013B2.LJA1	30"W x 13"D x 29"H, 2-Shelf, 1 Fixed Shelf Java Oak laminate	63	3.2	\$150
HLPLBC3013B2.LSE1	30"W x 13"D x 29"H, 2-Shelf, 1 Fixed Shelf Sepia Walnut laminate	63	3.2	\$150

LAMINATE STORAGE CABINETS

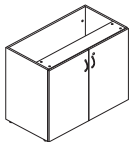

MODEL	DESCRIPTION	SHIP WEIGHT	CUBE	LIST PRICE
Storage Cabinet				
HLPLSC3620.LSL1	36"W x 20"D x 29"H Slate Teak laminate	79	15.7	\$356
HLPLSC3620.LTM1	36"W x 20"D x 29"H Traditional Mahogany laminate	79	15.7	\$356
HLPLSC3620.LRC1	36"W x 20"D x 29"H Russet Cherry laminate	79	15.7	\$356
HLPLSC3620.LJA1	36"W x 20"D x 29"H Java Oak laminate	79	15.7	\$356
HLPLSC3620.LSE1	36"W x 20"D x 29"H Sepia Walnut laminate	79	15.7	\$356

NOTES:

- Lateral files ship assembled.
- Drawers operate on full extension, ball-bearing suspensions to ensure smooth, quiet, and long-lasting operation.
- Hangrails are included in each file drawer for side-to-side legal filing, and for front-to-back letter and legal filing.
- Storage Cabinet, Wardrobe, and Lateral Files come standard with Arch pull in Silver finish.
- **HON 5-Year Limited Warranty.**

! Top is unfinished, not to be used freestanding. To convert to a freestanding cabinet, order model HLPLCL3620TOP.



LAMINATE WARDROBES

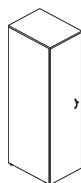

MODEL	DESCRIPTION	SHIP WEIGHT	CUBE	LIST PRICE
Wardrobe				
HLPLW2424.LSL1	24"W x 24"D x 65"H Slate Teak laminate	99	4.2	\$796
HLPLW2424.LTM1	24"W x 24"D x 65"H Traditional Mahogany laminate	99	4.2	\$796
HLPLW2424.LRC1	24"W x 24"D x 65"H Russet Cherry laminate	99	4.2	\$796
HLPLW2424.LJA1	24"W x 24"D x 65"H Java Oak laminate	99	4.2	\$796
HLPLW2424.LSE1	24"W x 24"D x 65"H Sepia Walnut laminate	99	4.2	\$796
HLPLW1824.LSL1	18"W x 24"D x 65"H Slate Teak laminate	84	4.2	\$521
HLPLW1824.LTM1	18"W x 24"D x 65"H Traditional Mahogany laminate	84	4.2	\$521
HLPLW1824.LRC1	18"W x 24"D x 65"H Russet Cherry laminate	84	4.2	\$521
HLPLW1824.LJA1	18"W x 24"D x 65"H Java Oak laminate	84	4.2	\$521
HLPLW1824.LSE1	18"W x 24"D x 65"H Sepia Walnut laminate	84	4.2	\$521

NOTES: Non-handed door which can be installed in left- or right-hand configuration. Coat rod, fixed shelf, and lock included.

LAMINATE LATERALS

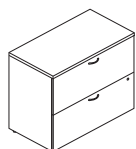

HLPLLF3620L2 shown

MODEL	DESCRIPTION	SHIP WEIGHT	CUBE	LIST PRICE
Laterals				
HLPLLF3620L4.LSL1	36"W x 20"D x 53"H, 4-Drawer Slate Teak laminate	193	27.4	\$887
HLPLLF3620L4.LTM1	36"W x 20"D x 53"H, 4-Drawer Traditional Mahogany laminate	193	27.4	\$887
HLPLLF3620L4.LRC1	36"W x 20"D x 53"H, 4-Drawer Russet Cherry laminate	193	27.4	\$887
HLPLLF3620L4.LJA1	36"W x 20"D x 53"H, 4-Drawer Java Oak laminate	193	27.4	\$887
HLPLLF3620L4.LSE1	36"W x 20"D x 53"H, 4-Drawer Sepia Walnut laminate	193	27.4	\$887
HLPLLF3620L3.LSL1	36"W x 20"D x 40"H, 3-Drawer Slate Teak laminate	166	21.1	\$784
HLPLLF3620L3.LTM1	36"W x 20"D x 40"H, 3-Drawer Traditional Mahogany laminate	166	21.1	\$784
HLPLLF3620L3.LRC1	36"W x 20"D x 40"H, 3-Drawer Russet Cherry laminate	166	21.1	\$784
HLPLLF3620L3.LJA1	36"W x 20"D x 40"H, 3-Drawer Java Oak laminate	166	21.1	\$784
HLPLLF3620L3.LSE1	36"W x 20"D x 40"H, 3-Drawer Sepia Walnut laminate	166	21.1	\$784

NOTES:

- Lateral files ship assembled.
- Drawers operate on full extension, ball-bearing suspensions to ensure smooth, quiet, and long-lasting operation.
- Hangrails are included in each file drawer for side-to-side legal filing, and for front-to-back letter and legal filing.
- Storage Cabinet, Wardrobe, and Lateral Files come standard with Arch pull in Silver finish.
- **HON 5-Year Limited Warranty.**



LAMINATE LATERALS

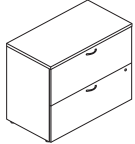

HLPLLF3620L2 shown

MODEL	DESCRIPTION	SHIP WEIGHT	CUBE	LIST PRICE
HLPLLF3620L2.LSL1	Lateral 36"W x 20"D x 29"H, 2-Drawer w/Removable Top Slate Teak laminate	145	15.7	\$504
HLPLLF3620L2.LTM1	36"W x 20"D x 29"H, 2-Drawer w/Removable Top Traditional Mahogany laminate	145	15.7	\$504
HLPLLF3620L2.LRC1	36"W x 20"D x 29"H, 2-Drawer w/Removable Top Russet Cherry laminate	145	15.7	\$504
HLPLLF3620L2.LJA1	36"W x 20"D x 29"H, 2-Drawer w/Removable Top Java Oak laminate	81.0	7.4	\$504
HLPLLF3620L2.LSE1	36"W x 20"D x 29"H, 2-Drawer w/Removable Top Sepia Walnut laminate	81.0	7.4	\$504
HLPLLF3620L2.LPW1	36"W x 20"D x 29"H, 2-Drawer w/Removable Top Simply White laminate	81.0	7.4	\$504

! To change the top of model HLPLLF3620L2 in order to make a two-tone unit, use model HLPLCL3620TOP, see page 17.

NOTES:

- Lateral files ship assembled.
- Drawers operate on full extension, ball-bearing suspensions to ensure smooth, quiet, and long-lasting operation.
- Hangrails are included in each file drawer for side-to-side legal filing, and for front-to-back letter and legal filing.
- Storage Cabinet, Wardrobe, and Lateral Files come standard with Arch pull in Silver finish.
- **HON 5-Year Limited Warranty.**

LAMINATE WORKSURFACES

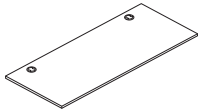

MODEL	DESCRIPTION	SHIP WEIGHT	CUBE	LIST PRICE
HLPLRW7230.LSL1	Rectangular Worksurface 72"W x 30"D Slate Teak laminate, Black grommets	110	6.0	\$191
HLPLRW7230.LTM1	72"W x 30"D Traditional Mahogany laminate, Black grommets	110	6.0	\$191
HLPLRW7230.LRC1	72"W x 30"D Russet Cherry laminate, Black grommets	110	6.0	\$191
HLPLRW7230.LJA1	72"W x 30"D Java Oak laminate, Black grommets	110	6.0	\$191
HLPLRW7230.LSE1	72"W x 30"D Sepia Walnut laminate, Black grommets	110	6.0	\$191
HLPLRW7230.LPW1	72"W x 30"D Simply White laminate, Black grommets	110	6.0	\$191
HLPLRW7224.LSL1	72"W x 24"D Slate Teak laminate, Black grommets	89	4.9	\$157
HLPLRW7224.LTM1	72"W x 24"D Traditional Mahogany laminate, Black grommets	89	4.9	\$157
HLPLRW7224.LRC1	72"W x 24"D Russet Cherry laminate, Black grommets	89	4.9	\$157
HLPLRW7224.LJA1	72"W x 24"D Java Oak laminate, Black grommets	89	4.9	\$157
HLPLRW7224.LSE1	72"W x 24"D Sepia Walnut laminate, Black grommets	89	4.9	\$157
HLPLRW72324.LPW1	72"W x 24"D Simply White laminate, Black grommets	89	4.9	\$157

NOTES:

- Scratch- and stain-resistant thermal-fused laminate surfaces.
- Durable 1" thick tops.
- **HON 5-Year Limited Warranty.**



LAMINATE WORKSURFACES

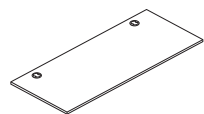

MODEL	DESCRIPTION	SHIP WEIGHT	CUBE	LIST PRICE
HLPLRW6630.LSL1	Rectangular Worksurface 66"W x 30"D Slate Teak laminate, Black grommets	101	5.5	\$179
HLPLRW6630.LTM1	66"W x 30"D Traditional Mahogany laminate, Black grommets	101	5.5	\$179
HLPLRW6630.LRC1	66"W x 30"D Russet Cherry laminate, Black grommets	101	5.5	\$179
HLPLRW6630.LJA1	66"W x 30"D Java Oak laminate, Black grommets	101	5.5	\$179
HLPLRW6630.LSE1	66"W x 30"D Sepia Walnut laminate, Black grommets	101	5.5	\$179
HLPLRW6630.LPW1	66"W x 30"D Simply White laminate, Black grommets	101	5.5	\$179
HLPLRW6624.LSL1	66"W x 24"D Slate Teak laminate, Black grommets	82	4.5	\$147
HLPLRW6624.LTM1	66"W x 24"D Traditional Mahogany laminate, Black grommets	82	4.5	\$147
HLPLRW6624.LRC1	66"W x 24"D Russet Cherry laminate, Black grommets	82	4.5	\$147
HLPLRW6624.LJA1	66"W x 24"D Java Oak laminate, Black grommets	82	4.5	\$147
HLPLRW6624.LSE1	66"W x 24"D Sepia Walnut laminate, Black grommets	82	4.5	\$147
HLPLRW6624.LPW1	66"W x 24"D Simply White laminate, Black grommets	82	4.5	\$147
HLPLRW6030.LSL1	60"W x 30"D Slate Teak laminate, Black grommets	92	5.0	\$169
HLPLRW6030.LTM1	60"W x 30"D Traditional Mahogany laminate, Black grommets	92	5.0	\$169
HLPLRW6030.LRC1	60"W x 30"D Russet Cherry laminate, Black grommets	92	5.0	\$169
HLPLRW6030.LJA1	60"W x 30"D Java Oak laminate, Black grommets	92	5.0	\$169
HLPLRW6030.LSE1	60"W x 30"D Sepia Walnut laminate, Black grommets	92	5.0	\$169
HLPLRW6030.LPW1	60"W x 30"D Traditional Mahogany laminate, Black grommets	92	5.0	\$169
HLPLRW6024.LSL1	60"W x 24"D Slate Teak laminate, Black grommet	75	4.1	\$139
HLPLRW6024.LTM1	60"W x 24"D Traditional Mahogany laminate, Black grommet	75	4.1	\$139
HLPLRW6024.LRC1	60"W x 24"D Russet Cherry laminate, Black grommet	75	4.1	\$139
HLPLRW6024.LJA1	60"W x 24"D Java Oak laminate, Black grommet	75	4.1	\$139
HLPLRW6024.LSE1	60"W x 24"D Sepia Walnut laminate, Black grommet	75	4.1	\$139
HLPLRW6024.LPW1	60"W x 24"D Simply White laminate, Black grommet	75	4.1	\$139

NOTES:

- Scratch- and stain-resistant thermal-fused laminate surfaces.
- Durable 1" thick tops.
- **HON 5-Year Limited Warranty.**



LAMINATE WORKSURFACES

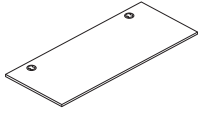

MODEL	DESCRIPTION	SHIP WEIGHT	CUBE	LIST PRICE
HLPLRW4830.LSL1	Rectangular Worksurface 48"W x 30"D Slate Teak laminate, Black grommets	75	4.1	\$161
HLPLRW4830.LTM1	48"W x 30"D Traditional Mahogany laminate, Black grommets	75	4.1	\$161
HLPLRW4830.LRC1	48"W x 30"D Russet Cherry laminate, Black grommets	75	4.1	\$161
HLPLRW4830.LJA1	48"W x 30"D Java Oak laminate, Black grommets	75	4.1	\$161
HLPLRW4830.LSE1	48"W x 30"D Sepia Walnut laminate, Black grommets	75	4.1	\$161
HLPLRW4830.LPW1	48"W x 30"D Simply White laminate, Black grommets	75	4.1	\$161
HLPLRW4824.LSL1	48"W x 24"D Slate Teak laminate, Black grommets	61	3.4	\$135
HLPLRW4824.LTM1	48"W x 24"D Traditional Mahogany laminate, Black grommets	61	3.4	\$135
HLPLRW4824.LRC1	48"W x 24"D Russet Cherry laminate, Black grommets	61	3.4	\$135
HLPLRW4824.LJA1	48"W x 24"D Java Oak laminate, Black grommets	61	3.4	\$135
HLPLRW4824.LSE1	48"W x 24"D Sepia Walnut laminate, Black grommets	61	3.4	\$135
HLPLRW4824.LPW1	48"W x 24"D Simply White laminate, Black grommets	61	3.4	\$135

NOTES:

- Scratch- and stain-resistant thermal-fused laminate surfaces.
- Durable 1" thick tops.
- **HON 5-Year Limited Warranty.**

EXTERNAL STIFFENER

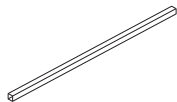

MODEL	DESCRIPTION	SHIP WEIGHT	CUBE	LIST PRICE
HLPLXS72.BLKP	External Stiffener For 72"W Worksurfaces, Black paint	7	0.7	\$75
HLPLXS66.BLKP	For 66"W Worksurfaces, Black paint	7	0.7	\$70
HLPLXS60.BLKP	For 60"W Worksurfaces, Black paint	7	0.7	\$65



METAL SUPPORT LEGS



MODEL	DESCRIPTION	SHIP WEIGHT	CUBE	LIST PRICE
HLPLLEG30A.BLKP	A-Leg Support 30"W Angled Leg Black paint	16	5.1	\$144
HLPLLEG30A.SLVR	30"W Angled Leg Silver paint	16	5.1	\$144
HLPLLEG24A.BLKP	24"W Angled Leg Black paint	14	3.7	\$135
HLPLLEG24A.SLVR	24"W Angled Leg Silver paint	14	3.7	\$135

NOTES: A-Leg supports have adjustable floor leveling glides which provide 2" of adjustment.

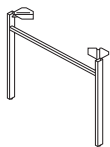

HLPLLEG30U.BLKP	U-Leg Support 30"W Angled Leg Black paint	17	5.1	\$144
HLPLLEG30U.SLVR	30"W Angled Leg Silver paint	17	5.1	\$144
HLPLLEG24U.BLKP	24"W Angled Leg Black paint	15	3.7	\$135
HLPLLEG24U.SLVR	24"W Angled Leg Silver paint	15	3.7	\$135

NOTES: U-Leg supports have adjustable floor leveling glides which provide 3" of adjustment.

STORAGE SUPPORT LEGS

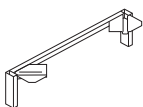

MODEL	DESCRIPTION	SHIP WEIGHT	CUBE	LIST PRICE
HLPLSL30.BLKP	Credenza Support Legs 7"H x 30"D Support Leg Black paint laminate	6	1.0	\$94
HLPLSL30.SLVR	7"H x 30"D Support Leg Silver paint	6	1.0	\$94
HLPLSL24.BLKP	7"H x 24"D Support Leg Black paint	5	1.0	\$86
HLPLSL24.SLVR	7"H x 24"D Support Leg Silver paint	5	1.0	\$86

HLPLOS23.BLKP	Overhead Support Legs 23"H Support Leg, Pack of 2 Black paint laminate	13	1.1	\$135
HLPLOS23.SLVR	23"H Support Leg, Pack of 2 Silver paint	13	1.1	\$135
HLPLOS10.BLKP	10½"H Support Leg, Pack of 2 Black paint	9	0.8	\$105
HLPLOS10.SLVR	10½"H Support Leg, Pack of 2 Silver paint	9	0.8	\$105

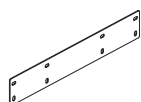

HLPLFB24	Flat Bracket 24"D Flat Bracket Graphite finish	3	0.6	\$45
-----------------	-------------------------------------------------------------	---	-----	-------------



LAMINATE LOW CREDENZAS

	MODEL	DESCRIPTION	SHIP WEIGHT	CUBE	LIST PRICE
		Low Credenza, 2 Drawers, Personal Cabinet, No Top			
	HPLCL3620BF.LSL1	36"W x 20"D x 21"H Slate Teak laminate	113	11.8	\$516
	HPLCL3620BF.LTM1	36"W x 20"D x 21"H Traditional Mahogany laminate	113	11.8	\$516
	HPLCL3620BF.LRC1	36"W x 20"D x 21"H Russet Cherry laminate	113	11.8	\$516
	HPLCL3620BF.LJA1	36"W x 20"D x 21"H Java Oak laminate	113	11.8	\$516
	HPLCL3620BF.LSE1	36"W x 20"D x 21"H Sepia Walnut laminate	113	11.8	\$516
	HPLCL3620BF.LPW1	36"W x 20"D x 21"H Simply White laminate	113	11.8	\$516
	HPLCL3020BF.LSL1	30"W x 20"D x 21"H Slate Teak laminate	80	10.1	\$505
	HPLCL3020BF.LTM1	30"W x 20"D x 21"H Traditional Mahogany laminate	80	10.1	\$505
	HPLCL3020BF.LRC1	30"W x 20"D x 21"H Russet Cherry laminate	80	10.1	\$505
	HPLCL3020BF.LJA1	30"W x 20"D x 21"H Java Oak laminate	80	10.1	\$505
	HPLCL3020BF.LSE1	30"W x 20"D x 21"H Sepia Walnut laminate	80	10.1	\$505
HPLCL3020BF.LPW1	30"W x 20"D x 21"H Simply White laminate	80	10.1	\$505	
		Low Credenza, 2 Open Shelves, Open Storage Cabinet, No Top			
	HPLCL3620S.LSL1	36"W x 20"D x 21"H Slate Teak laminate	63	3.0	\$243
	HPLCL3620S.LTM1	36"W x 20"D x 21"H Traditional Mahogany laminate	63	3.0	\$243
	HPLCL3620S.LRC1	36"W x 20"D x 21"H Russet Cherry laminate	63	3.0	\$243
	HPLCL3620S.LJA1	36"W x 20"D x 21"H Java Oak laminate	63	3.0	\$243
	HPLCL3620S.LSE1	36"W x 20"D x 21"H Sepia Walnut laminate	63	3.0	\$243
	HPLCL3620S.LPW1	36"W x 20"D x 21"H Simply White laminate	63	3.0	\$243
	HPLCL3020S.LSL1	30"W x 20"D x 21"H Slate Teak laminate	48	2.5	\$232
	HPLCL3020S.LTM1	30"W x 20"D x 21"H Traditional Mahogany laminate	48	2.5	\$232
	HPLCL3020S.LRC1	30"W x 20"D x 21"H Russet Cherry laminate	48	2.5	\$232
	HPLCL3020S.LJA1	30"W x 20"D x 21"H Java Oak laminate	48	2.5	\$232
	HPLCL3020S.LSE1	30"W x 20"D x 21"H Sepia Walnut laminate	48	2.5	\$232
HPLCL3020S.LPW1	30"W x 20"D x 21"H Simply White laminate	48	2.5	\$232	

NOTES:

- Scratch- and stain-resistant thermal-fused laminate surfaces.
- Durable 1" thick tops.
- Low credenzas ship assembled.
- Drawers operate on full extension, ball-bearing suspensions to ensure smooth, quiet, and long-lasting operation.
- Hangrails are included in each file drawer for side-to-side legal filing, and for front-to-back letter and legal filing.
- Low Credenza, 2 Drawer comes standard with Arch pull in Silver finish.
- **HON 5-Year Limited Warranty.**



LOW CREDENZA TOPS

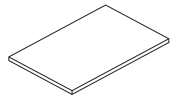

MODEL	DESCRIPTION	SHIP WEIGHT	CUBE	LIST PRICE
	Low Credenza Cabinet Tops			
HLPLCL7220TOP.LSL1	72"W x 20"D Slate Teak laminate	74	4.2	\$127
HLPLCL7220TOP.LTM1	72"W x 20"D Traditional Mahogany laminate	74	4.2	\$127
HLPLCL7220TOP.LRC1	72"W x 20"D Russet Cherry laminate	74	4.2	\$127
HLPLCL7220TOP.LJA1	72"W x 20"D Java Oak laminate	74	4.2	\$127
HLPLCL7220TOP.LSE1	72"W x 20"D Sepia Walnut laminate	74	4.2	\$127
HLPLCL7220TOP.LPW1	72"W x 20"D Simply White laminate	74	4.2	\$127
HLPLCL6620TOP.LSL1	66"W x 20"D Slate Teak laminate	68	3.9	\$125
HLPLCL6620TOP.LTM1	66"W x 20"D Traditional Mahogany laminate	68	3.9	\$125
HLPLCL6620TOP.LRC1	66"W x 20"D Russet Cherry laminate	68	3.9	\$125
HLPLCL6620TOP.LJA1	66"W x 20"D Java Oak laminate	68	3.9	\$125
HLPLCL6620TOP.LSE1	66"W x 20"D Sepia Walnut laminate	68	3.9	\$125
HLPLCL6620TOP.LPW1	66"W x 20"D Simply White laminate	68	3.9	\$125
HLPLCL6020TOP.LSL1	60"W x 20"D Slate Teak laminate	63	3.5	\$116
HLPLCL6020TOP.LTM1	60"W x 20"D Traditional Mahogany laminate	63	3.5	\$116
HLPLCL6020TOP.LRC1	60"W x 20"D Russet Cherry laminate	63	3.5	\$116
HLPLCL6020TOP.LJA1	60"W x 20"D Java Oak laminate	63	3.5	\$116
HLPLCL6020TOP.LSE1	60"W x 20"D Sepia Walnut laminate	63	3.5	\$116
HLPLCL6020TOP.LPW1	60"W x 20"D Simply White laminate	63	3.5	\$116

NOTES:

- Scratch- and stain-resistant thermal-fused laminate surfaces.
- Durable 1" thick tops.
- **HON 5-Year Limited Warranty.**



LOW CREDENZA TOPS

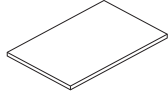

MODEL	DESCRIPTION	SHIP WEIGHT	CUBE	LIST PRICE
Low Credenza Cabinet Tops				
HLPLCL3620TOP.LSL1	36"W x 20"D Slate Teak laminate	37	2.2	\$82
HLPLCL3620TOP.LTM1	36"W x 20"D Traditional Mahogany laminate	37	2.2	\$82
HLPLCL3620TOP.LRC1	36"W x 20"D Russet Cherry laminate	37	2.2	\$82
HLPLCL3620TOP.LJA1	36"W x 20"D Java Oak laminate	37	2.2	\$82
HLPLCL3620TOP.LSE1	36"W x 20"D Sepia Walnut laminate	37	2.2	\$82
HLPLCL3620TOP.LPW1	36"W x 20"D Simply White laminate	37	2.2	\$82
Low Credenza Open Tops				
HLPLCL3020TOP.LSL1	30"W x 20"D Slate Teak laminate	30	1.9	\$75
HLPLCL3020TOP.LTM1	30"W x 20"D Traditional Mahogany laminate	30	1.9	\$75
HLPLCL3020TOP.LRC1	30"W x 20"D Russet Cherry laminate	30	1.9	\$75
HLPLCL3020TOP.LJA1	30"W x 20"D Java Oak laminate	30	1.9	\$75
HLPLCL3020TOP.LSE1	30"W x 20"D Sepia Walnut laminate	30	1.9	\$75
HLPLCL3020TOP.LPW1	30"W x 20"D Simply White laminate	30	1.9	\$75

NOTES:

- Scratch- and stain-resistant thermal-fused laminate surfaces.
- Durable 1" thick tops.
- **HON 5-Year Limited Warranty.**

LOW CREDENZA CUSHIONS

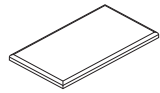

MODEL	DESCRIPTION	SHIP WEIGHT	CUBE	LIST PRICE
Low Credenza Cushion				
HLPLCSEAT3620.CN02	36"W x 20"D Cool Neutral fabric	11	2.2	\$175
HLPLCSEAT3620.WM01	36"W x 20"D Warm Neutral fabric	11	2.2	\$175
HLPLCSEAT3020.CN02	30"W x 20"D Cool Neutral fabric	9	1.9	\$180
HLPLCSEAT3020.WM01	30"W x 20"D Warm Neutral fabric	9	1.9	\$180



LAMINATE TABLE TOPS

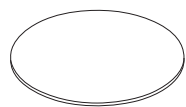

MODEL	DESCRIPTION	SHIP WEIGHT	CUBE	LIST PRICE
Round Conference Table Tops				
HLPLTBL48RND.LSL1	48" Round Top Slate Teak laminate	63	6.5	\$201
HLPLTBL48RND.LTM1	48" Round Top Traditional Mahogany laminate	63	6.5	\$201
HLPLTBL48RND.LRC1	48" Round Top Russet Cherry laminate	63	6.5	\$201
HLPLTBL48RND.LJA1	48" Round Top Java Oak laminate	63	6.5	\$201
HLPLTBL48RND.LSE1	48" Round Top Sepia Walnut laminate	63	6.5	\$201
HLPLTBL48RND.LPW1	48" Round Top Simply White laminate	63	6.5	\$201
HLPLTBL42RND.LSL1	42" Round Top Slate Teak laminate	50	5.1	\$196
HLPLTBL42RND.LTM1	42" Round Top Traditional Mahogany laminate	50	5.1	\$196
HLPLTBL42RND.LRC1	42" Round Top Russet Cherry laminate	50	5.1	\$196
HLPLTBL42RND.LJA1	42" Round Top Java Oak laminate	50	5.1	\$196
HLPLTBL42RND.LSE1	42" Round Top Sepia Walnut laminate	50	5.1	\$196
HLPLTBL42RND.LPW1	42" Round Top Simply White laminate	50	5.1	\$196
HLPLTBL36RND.LSL1	36" Round Top Slate Teak laminate	39	3.8	\$161
HLPLTBL36RND.LTM1	36" Round Top Traditional Mahogany laminate	39	3.8	\$161
HLPLTBL36RND.LRC1	36" Round Top Russet Cherry laminate	39	3.8	\$161
HLPLTBL36RND.LJA1	36" Round Top Java Oak laminate	39	3.8	\$161
HLPLTBL36RND.LSE1	36" Round Top Sepia Walnut laminate	39	3.8	\$161
HLPLTBL36RND.LPW1	36" Round Top Simply White laminate	39	3.8	\$161

NOTES:

- Scratch- and stain-resistant thermal-fused laminate surfaces.
- Durable 1" thick tops.
- **HON 5-Year Limited Warranty.**



LAMINATE ROUND TABLE BASES

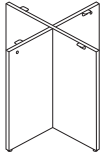

MODEL	DESCRIPTION	SHIP WEIGHT	CUBE	LIST PRICE
	Round Conference Table Bases			
HLPLTBL48BASE.LSL1	X-Base for 48" Table Tops Slate Teak laminate	45	3.2	\$105
HLPLTBL48BASE.LTM1	X-Base for 48" Table Tops Traditional Mahogany laminate	45	3.2	\$105
HLPLTBL48BASE.LRC1	X-Base for 48" Table Tops Russet Cherry laminate	45	3.2	\$105
HLPLTBL48BASE.LJA1	X-Base for 48" Table Tops Java Oak laminate	45	3.2	\$105
HLPLTBL48BASE.LSE1	X-Base for 48" Table Tops Sepia Walnut laminate	45	3.2	\$105
HLPLTBL48BASE.LPW1	X-Base for 48" Table Tops Simply White laminate	45	3.2	\$105
HLPLTBL42BASE.LSL1	X-Base for 42" Table Tops Slate Teak laminate	42	3.2	\$100
HLPLTBL42BASE.LTM1	X-Base for 42" Table Tops Traditional Mahogany laminate	42	3.2	\$100
HLPLTBL42BASE.LRC1	X-Base for 42" Table Tops Russet Cherry laminate	42	3.2	\$100
HLPLTBL42BASE.LJA1	X-Base for 42" Table Tops Java Oak laminate	42	3.2	\$100
HLPLTBL42BASE.LSE1	X-Base for 42" Table Tops Sepia Walnut laminate	42	3.2	\$100
HLPLTBL42BASE.LPW1	X-Base for 42" Table Tops Simply White laminate	42	3.2	\$100
HLPLTBL36BASE.LSL1	X-Base for 36" Table Tops Slate Teak laminate	36	2.5	\$95
HLPLTBL36BASE.LTM1	X-Base for 36" Table Tops Traditional Mahogany laminate	36	2.5	\$95
HLPLTBL36BASE.LRC1	X-Base for 36" Table Tops Russet Cherry laminate	36	2.5	\$95
HLPLTBL36BASE.LJA1	X-Base for 36" Table Tops Java Oak laminate	36	2.5	\$95
HLPLTBL36BASE.LSE1	X-Base for 36" Table Tops Sepia Walnut laminate	36	2.5	\$95
HLPLTBL36BASE.LPW1	X-Base for 36" Table Tops Simply White laminate	36	2.5	\$95

NOTES:

- Scratch- and stain-resistant thermal-fused laminate surfaces.
- Durable 1" support legs.
- **HON 5-Year Limited Warranty.**



LAMINATE TABLE TOPS

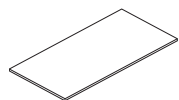

MODEL	DESCRIPTION	SHIP WEIGHT	CUBE	LIST PRICE
	Rectangle Conference Table Tops			
HLPLTBL48120RCT.LSL1	48"W x 120"L Rectangular Top, 2-Piece Slate Teak laminate	293	7.8	\$658
HLPLTBL48120RCT.LTM1	48"W x 120"L Rectangular Top, 2-Piece Traditional Mahogany laminate	293	7.8	\$658
HLPLTBL48120RCT.LRC1	48"W x 120"L Rectangular Top, 2-Piece Russet Cherry laminate	293	7.8	\$658
HLPLTBL48120RCT.LJA1	48"W x 120"L Rectangular Top, 2-Piece Java Oak laminate	293	7.8	\$658
HLPLTBL48120RCT.LSE1	48"W x 120"L Rectangular Top, 2-Piece Sepia Walnut laminate	293	7.8	\$658
HLPLTBL48120RCT.LPW1	48"W x 120"L Rectangular Top, 2-Piece Simply White laminate	293	7.8	\$658
HLPLTBL4296RCT.LSL1	42"W x 96"L Rectangular Top Slate Teak laminate	205	10.7	\$453
HLPLTBL4296RCT.LTM1	42"W x 96"L Rectangular Top Traditional Mahogany laminate	205	10.7	\$453
HLPLTBL4296RCT.LRC1	42"W x 96"L Rectangular Top Russet Cherry laminate	205	10.7	\$453
HLPLTBL4296RCT.LJA1	42"W x 96"L Rectangular Top Java Oak laminate	205	10.7	\$453
HLPLTBL4296RCT.LSE1	42"W x 96"L Rectangular Top Sepia Walnut laminate	205	10.7	\$453
HLPLTBL4296RCT.LPW1	42"W x 96"L Rectangular Top Simply White laminate	205	10.7	\$453
HLPLTBL3672RCT.LSL1	36"W x 72"L Rectangular Top Slate Teak laminate	132	7.1	\$267
HLPLTBL3672RCT.LTM1	36"W x 72"L Rectangular Top Traditional Mahogany laminate	132	7.1	\$267
HLPLTBL3672RCT.LRC1	36"W x 72"L Rectangular Top Russet Cherry laminate	132	7.1	\$267
HLPLTBL3672RCT.LJA1	36"W x 72"L Rectangular Top Java Oak laminate	132	7.1	\$267
HLPLTBL3672RCT.LSE1	36"W x 72"L Rectangular Top Sepia Walnut laminate	132	7.1	\$267
HLPLTBL3672RCT.LPW1	36"W x 72"L Rectangular Top Simply White laminate	132	7.1	\$267

NOTES:

- Scratch- and stain-resistant thermal-fused laminate surfaces.
- Durable 1" thick tops.
- **HON 5-Year Limited Warranty.**



LAMINATE RECTANGLE TABLE BASES

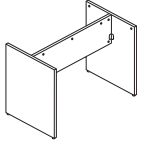

MODEL	DESCRIPTION	SHIP WEIGHT	CUBE	LIST PRICE
Rectangle Conference Table Bases				
HLPLTBL120BASE.LSL1	Slab Base for 120" Table Tops Slate Teak laminate	86	4.2	\$105
HLPLTBL120BASE.LTM1	Slab Base for 120" Table Tops Traditional Mahogany laminate	86	4.2	\$105
HLPLTBL120BASE.LRC1	Slab Base for 120" Table Tops Russet Cherry laminate	86	4.2	\$105
HLPLTBL120BASE.LJA1	Slab Base for 120" Table Tops Java Oak laminate	86	4.2	\$105
HLPLTBL120BASE.LSE1	Slab Base for 120" Table Tops Sepia Walnut laminate	86	4.2	\$105
HLPLTBL120BASE.LPW1	Slab Base for 120" Table Tops Simply White laminate	86	4.2	\$105
HLPLTBL96BASE.LSL1	Slab Base for 96" Table Tops Slate Teak laminate	64	5.1	\$100
HLPLTBL96BASE.LTM1	Slab Base for 96" Table Tops Traditional Mahogany laminate	64	5.1	\$100
HLPLTBL96BASE.LRC1	Slab Base for 96" Table Tops Russet Cherry laminate	64	5.1	\$100
HLPLTBL96BASE.LJA1	Slab Base for 96" Table Tops Java Oak laminate	64	5.1	\$100
HLPLTBL96BASE.LSE1	Slab Base for 96" Table Tops Sepia Walnut laminate	64	5.1	\$100
HLPLTBL96BASE.LPW1	Slab Base for 96" Table Tops Simply White laminate	64	5.1	\$100
HLPLTBL72BASE.LSL1	Slab Base for 72" Table Tops Slate Teak laminate	48	3.0	\$95
HLPLTBL72BASE.LTM1	Slab Base for 72" Table Tops Traditional Mahogany laminate	48	3.0	\$95
HLPLTBL72BASE.LRC1	Slab Base for 72" Table Tops Russet Cherry laminate	48	3.0	\$95
HLPLTBL72BASE.LJA1	Slab Base for 72" Table Tops Java Oak laminate	48	3.0	\$95
HLPLTBL72BASE.LSE1	Slab Base for 72" Table Tops Sepia Walnut laminate	48	3.0	\$95
HLPLTBL72BASE.LPW1	Slab Base for 72" Table Tops Simply White laminate	48	3.0	\$95

NOTES:

- Scratch- and stain-resistant thermal-fused laminate surfaces.
- Durable 1" thick tops.
- **HON 5-Year Limited Warranty.**



LAMINATE RECEPTION DESK SHELLS

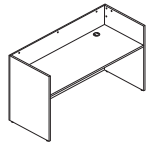

MODEL	DESCRIPTION	SHIP WEIGHT	CUBE	LIST PRICE
	Reception Desk Shells			
HLPLRCPNDS7230.LSL1	72"W x 30"D x 41"H Slate Teak laminate	182	8.3	\$406
HLPLRCPNDS7230.LTM1	72"W x 30"D x 41"H Traditional Mahogany laminate	182	8.3	\$406
HLPLRCPNDS7230.LRC1	72"W x 30"D x 41"H Russet Cherry laminate	182	8.3	\$406
HLPLRCPNDS7230.LJA1	72"W x 30"D x 41"H Java Oak laminate	182	8.3	\$406
HLPLRCPNDS7230.LSE1	72"W x 30"D x 41"H Sepia Walnut laminate	182	8.3	\$406

LAMINATE RECEPTION RETURN SHELLS

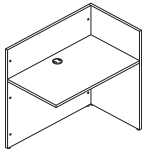

MODEL	DESCRIPTION	SHIP WEIGHT	CUBE	LIST PRICE
	Reception Return Shells			
HLPLRCPNRS4225.LSL1	42"W x 25"D x 41"H Slate Teak laminate	110	5.1	\$245
HLPLRCPNRS4225.LTM1	42"W x 25"D x 41"H Traditional Mahogany laminate	110	5.1	\$245
HLPLRCPNRS4225.LRC1	42"W x 25"D x 41"H Russet Cherry laminate	110	5.1	\$245
HLPLRCPNRS4225.LJA1	42"W x 25"D x 41"H Java Oak laminate	110	5.1	\$245
HLPLRCPNRS4225.LSE1	42"W x 25"D x 41"H Sepia Walnut laminate	110	5.1	\$245

TRANSACTION TOPS

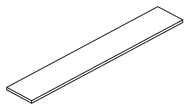

MODEL	DESCRIPTION	SHIP WEIGHT	CUBE	LIST PRICE
	Laminate Transaction Tops			
HLPLRCPNTPLM.LSL1	72"W x 12"D Slate Teak laminate	45	3.5	\$86
HLPLRCPNTPLM.LTM1	72"W x 12"D Traditional Mahogany laminate	45	3.5	\$86
HLPLRCPNTPLM.LRC1	72"W x 12"D Russet Cherry laminate	45	3.5	\$86
HLPLRCPNTPLM.LJA1	72"W x 12"D Java Oak laminate	45	3.5	\$86
HLPLRCPNTPLM.LSE1	72"W x 12"D Sepia Walnut laminate	45	3.5	\$86
HLPLRCPNTPLM.LSE1	72"W x 12"D Simply White laminate	45	3.5	\$86
HLPLRCPNTPGS	72"W x 12"D Frosted Glass	35	3.2	\$304

NOTES:

- Scratch- and stain-resistant thermal-fused laminate surfaces.
- Durable 1" thick tops and end panels.
- Adjustable floor leveling glides provide 3/4" of adjustment.
- Reception stations assemble quickly and easily.
- 3" round Black grommet(s) in tops of desks to route cords.
- **HON 5-Year Limited Warranty.**

NOW Voi® Desking

QTY	DESCRIPTION	MODEL	LIST PRICE	PRICE EXTENSION
1	Support Pedestal – B/B/F 24"D x 28"H	HLSL2428B	\$778	\$778
2	Rectangle Worksurface 24"D x 48"W	HLSLR2448	\$306	\$306
3	O-Leg Support for Worksurface 24"D x 28"H	HLSL2428O	\$324	\$972
1	Mobile Pedestal 15¾"W x 20⅞"D x 21⅞"H	HLSL2016MP2	\$813	\$813
1	Mobile Pedestal Cushion 20"D x 15⅝"W x 1"H	HLSL2016PH2	\$339	\$339
1	Mixed Material Floating Modesty Panel 42"W x 14"H	HLSL4214MM	\$826	\$826
TOTAL:				\$4,034

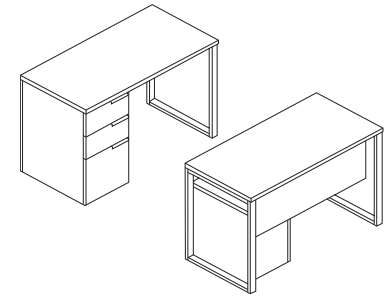

WORKSTATION, O-LEG
90"W x 48"D

QTY	DESCRIPTION	MODEL	LIST PRICE	PRICE EXTENSION
1	Rectangle Worksurface 30"D x 66"W	HLSLR3066	\$441	\$441
1	Rectangle Worksurface 24"D x 48"W	HLSLR2448	\$306	\$306
2	O-Leg Support for Worksurface 28"D x 30"H	HLSL3028O	\$359	\$718
1	Mixed Material Floating Modesty Panel 54"W x 14"H	HLSL5414MM	\$992	\$992
1	Support Pedestal – B/B/F 24"D x 28"H	HLSL2428B	\$778	\$778
1	Mobile Pedestal 15¾"W x 20⅞"D x 21⅞"H	HLSL2016MP2	\$813	\$813
1	Mobile Pedestal Cushion 20"D x 15⅝"W x 1"H	HLSL2016PH2	\$339	\$339
TOTAL:				\$4,387

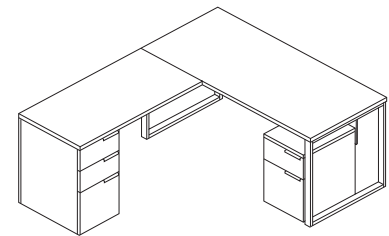

L-STATION, O-LEG
78"W x 66"D

NOW Voi® Desking

QTY	DESCRIPTION	MODEL	LIST PRICE	PRICE EXTENSION
2	Angled Steel Legs 29"H	HLSL28AM2	\$323	\$646
1	Rectangle Worksurface 30"D x 60"W	HLSLR3060	\$410	\$410
1	Rectangle Worksurface 24"D x 48"W	HLSLR2448	\$306	\$306
1	Support Pedestal - B/B/F 24"D x 28"H	HLSL2428B	\$778	\$778
1	Mixed Material Floating Modesty Panel 48"W x 14"H	HLSL4814MM	\$914	\$914
TOTAL:			\$3,054	

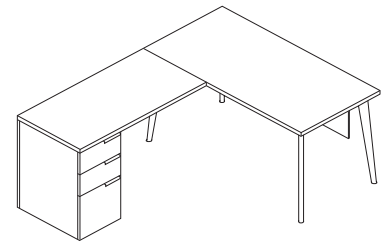

L-STATION, ANGLED LEG
78"W x 60"D

QTY	DESCRIPTION	MODEL	LIST PRICE	PRICE EXTENSION
1	Rectangle Worksurface 30"D x 66"W	HLSLR3066	\$441	\$441
2	Angled Steel Legs 29"H	HLSL28AM2	\$323	\$646
1	Low Credenza - 2 File Drawers, Open Top 20"D x 60"W	HLSL2060LD2	\$1,405	\$1,405
1	Mixed Material Floating Modesty Panel 54"W x 14"H	HLSL5414MM	\$992	\$992
TOTAL:			\$3,484	

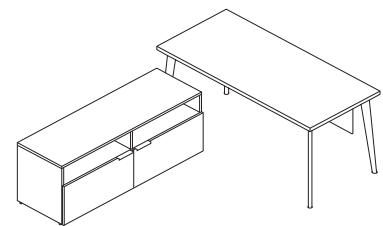

L-STATION, ANGLED LEG
90"W x 66"D

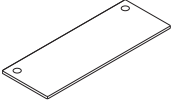
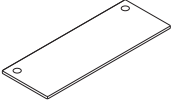

LAMINATE WORKSURFACES

	MODEL	DESCRIPTION	SHIP WEIGHT	CUBE	LIST PRICE
	HLSLR2448.LDW1DW.GDW	Rectangle Worksurfaces 48"W x 24"D Designer White laminate, Designer White grommet	61	3.4	\$306
	HLSLR2448.LFW1FW.GDW	48"W x 24"D Florence Walnut laminate, Designer White grommet	61	3.4	\$306
	HLSLR2448.PINCPINC.GDW	48"W x 24"D Pinnacle laminate, Designer White grommet	61	3.4	\$306
	HLSLR3060.LDW1DW.GDW	Rectangle Worksurfaces 60"W x 30"D Designer White laminate, Designer White grommet	92	5.1	\$410
	HLSLR3060.LFW1FW.GDW	60"W x 30"D Florence Walnut laminate, Designer White grommet	92	5.1	\$410
	HLSLR3060.PINCPINC.GDW	60"W x 30"D Pinnacle laminate, Designer White grommet	92	5.1	\$410
	HLSLR3066.LDW1DW.GDW	66"W x 30"D Designer White laminate, Designer White grommet	101	6.1	\$441
	HLSLR3066.LFW1FW.GDW	66"W x 30"D Florence Walnut laminate, Designer White grommet	101	6.1	\$441
	HLSLR3066.PINCPINC.GDW	66"W x 30"D Pinnacle laminate, Designer White grommet	101	6.1	\$441
	HLSLR3072.LDW1DW.GDW	72"W x 30"D Designer White laminate, Designer White grommet	110	6.1	\$480
	HLSLR3072.LFW1FW.GDW	72"W x 30"D Florence Walnut laminate, Designer White grommet	110	6.1	\$480
	HLSLR3072.PINCPINC.GDW	72"W x 30"D Pinnacle laminate, Designer White grommet	110	6.1	\$480

NOTES:

- Systems worksurfaces can be used with all Voi components.
- Worksurfaces are abrasion- and stain-resistant laminate over durable 1½" solid core high performance particleboard: resists warping.
- One flat bracket ships with each worksurface.
- Square edge detail.
- When using a floating modesty panel or an external channel under the worksurface, the depth clearance for keyboard trays and center drawers decreases by 8".
- ! When using a worksurface as a bridge, no additional supports are needed. One support is required for returns, two supports are required for desks and credenzas.
- ! Depending on your support combination, an external channel may be required for extra support on unsupported spans greater than 54"W.
- ! If using a 54"W or 60"W floating modesty, it is not necessary to spec an external channel.
- ! When attaching worksurfaces to panels, one or more of the following are required: anti-dislodgement brackets, end panel, support leg and/or cantilevers. Cantilevers and anti-dislodgement brackets must be ordered separately when attaching worksurfaces to panels.
- ! A return worksurface is considered 48"W or shorter. Longer returns cannot be supported by a flat bracket only.

WORKSURFACE SUPPORTS — COMPONENTS

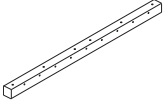
	MODEL	DESCRIPTION	SHIP WEIGHT	CUBE	LIST PRICE
		External Support Channel			
	HLSLZ5SC54.P	42"W for a 54" Worksurface	6	0.5	\$93
	HLSLZ5SC60.P	48"W for a 60" Worksurface	6	0.5	\$98
	HLSLZ5SC66.P	54"W for a 66" Worksurface	7	0.5	\$101
	HLSLZ5SC72.P	60"W for a 72" Worksurface	7	0.5	\$110

NOTES:

- ! Available in Graphite paint only.
- ! When specifying a 54"W or 60"W Floating Modesty Panel, it is not necessary to specify an external channel.

WORKSURFACE SUPPORTS — O-LEG

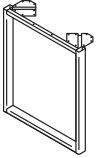
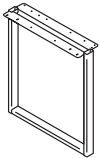
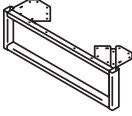
	MODEL	DESCRIPTION	SHIP WEIGHT	CUBE	LIST PRICE
		O-Leg Support for Worksurfaces			
	HLSL24280.PJW	24"D x 28½"H Designer White paint	17	3.7	\$324
	HLSL24280.PR6	24"D x 28½"H Silver paint	17	3.7	\$328
	HLSL30280.PJW	30"D x 28½"H Designer White paint	19	5.4	\$359
	HLSL30280.PR6	30"D x 28½"H Silver paint	19	5.4	\$363
		O-Leg Shared Support for Worksurfaces			
	HLSL3028SL.PJW	30"D x 28½"H Designer White paint	19	5.4	\$447
	HLSL3028SL.PR6	30"D x 28½"H Silver paint	19	5.4	\$451
		O-Leg Support for Low Credenzas			
	HLSL3070.PJW	30"D x 7"H Designer White paint	7	1.0	\$277
	HLSL3070.PR6	30"D x 7"H Silver paint	7	1.0	\$281

NOTES:

- Ship fully assembled, 1/pack. Non-handed.
- A variety of pedestals, end panels, and O-legs can be combined to create a conventional or contemporary desk.
- O-leg ships fully assembled with mounting hardware.
- Glides on O-Leg Support for Worksurfaces and Post Leg Base have 2" of adjustability. No glides on 7"H O-leg. Glides on end panels have 1¼" adjustability.
- ! O-legs may only be attached to worksurfaces, not storage units.

WORKSURFACE SUPPORTS — ANGLED LEGS

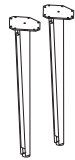

OPEN MARKET

MODEL	DESCRIPTION	SHIP WEIGHT	CUBE	LIST PRICE
HL28AM2.PJW	Angled Legs 12"W x 8"D x 32"H Steel — 2-Pack Designer White paint	15 Ⓞ	1.3	\$323
HL28AM2.PR6	12"W x 8"D x 32"H Steel — 2-Pack Silver paint	15 Ⓞ	1.3	\$331

NOTES:

- Angled Steel Legs come equipped with a removable wire management channel in each leg.
- Pricing shown is per carton. Ordering 2 of either model will result in 2 cartons being shipped, giving you 4 legs.

LAMINATE SUPPORT PEDESTALS

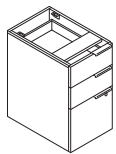

SIN 33721

MODEL	DESCRIPTION	SHIP WEIGHT	CUBE	LIST PRICE
HL2428B.LDW1.LDW1.PR6	Support Pedestals — Box/Box/File 16"W x 24"D x 28½"H Designer White chassis, Designer White drawer fronts, Silver pulls	85	8.5	\$778
HL2428B.LFW1.LFW1.PR6	16"W x 24"D x 28½"H Florence Walnut chassis, Florence Walnut drawer fronts, Silver pulls	85	8.5	\$778
HL2428B.PINC.PINC.PR6	16"W x 24"D x 28½"H Pinnacle chassis, Pinnacle drawer fronts, Silver pulls	85	8.5	\$778

NOTES:

- Top box drawer does not lock.
- A variety of pedestals, end panels, and O-legs can be combined to create a conventional or contemporary desk.
- File drawers accept hanging folders in letter or legal size.
- Multiple handle locations possible per customer preference.
- Ships with one handle per drawer.
- Box and file drawers operate on ball-bearing suspension with full extension.
- Adjustable hex leveling glides allow floor-standing furniture to be easily leveled without lifting the unit; glides have 1/4" adjustable range.
- Pedestals ship fully assembled but must attach to a worksurface with a quick release bracket, provided. Pedestals are non-handed and are interchangeable.
- Locking units equipped with HON "One Key" interchangeable core removable locks. Keyed alike core must be ordered separately.

MODESTY PANELS

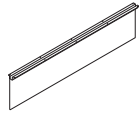

MODEL	DESCRIPTION	SHIP WEIGHT	CUBE	LIST PRICE
HLSL4214MM.FT01.P	Mixed Material Floating Modesty Panel 42"W x 14"H Frosted Translucent mixed material	9	2.3	\$826
HLSL4814MM.FT01.P	48"W x 14"H Frosted Translucent mixed material	11	2.6	\$914
HLSL5414MM.FT01.P	54"W x 14"H Frosted Translucent mixed material	13	3.3	\$992
HLSL6014MM.FT01.P	60"W x 14"H Frosted Translucent mixed material	13	3.3	\$1134

NOTES:

- The attachment bracket and modesty panel are packaged separately.
- ! When specifying the 54"W or 60"W Mixed Material Floating Modesty Panel, it is not necessary to specify an external channel.

LAMINATE LOW CREDENZAS

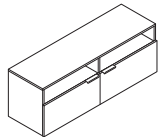

MODEL	DESCRIPTION	SHIP WEIGHT	CUBE	LIST PRICE
HLSL2060LD2.LDW1.LDW1.PR6	Low Credenza, 2 File Drawers, Open Top 60"W x 20"D x 21½"H Designer White chassis and drawer fronts, Silver pulls	160	18.9	\$1405
HLSL2060LD2.LFW1.LFW1.PR6	60"W x 20"D x 21½"H Florence Walnut chassis and drawer fronts, Silver pulls	160	18.9	\$1405
HLSL2060LD2.PINC.PINC.PR6	60"W x 20"D x 21½"H Pinnacle chassis and drawer fronts, Silver pulls	160	18.9	\$1405

NOTES:

- Unit is non-locking.
- Worksurfaces with 7" O-legs, may be placed upon low credenzas to create layering.
- File drawers accept hanging folders in letter size.
- Multiple handle locations possible per customer preference.
- Drawers operate on ball-bearing suspension with full extension.
- Adjustable hex leveling glides allow floor-standing furniture to be easily leveled without lifting the unit; glides have 1/4" adjustable range.
- Ships with one handle per drawer.



LAMINATE MOBILE STORAGE

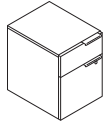

MODEL	DESCRIPTION	SHIP WEIGHT	CUBE	LIST PRICE
HLSL2016MP2.LDW1.LDW1.PR6	Mobile Pedestal 15 ³ / ₄ "W x 20 ¹ / ₁₆ "D x 21 ⁷ / ₁₆ "H Designer White chassis, Designer White drawer fronts, Silver pulls	65	5.7	\$813
HLSL2016MP2.LFW1.LFW1.PR6	15 ³ / ₄ "W x 20 ¹ / ₁₆ "D x 21 ⁷ / ₁₆ "H Florence Walnut chassis, Florence Walnut drawer fronts, Silver pulls	65	5.7	\$813
HLSL2016MP2.PINC.PINC.PR6	15 ³ / ₄ "W x 20 ¹ / ₁₆ "D x 21 ⁷ / ₁₆ "H Pinnacle chassis, Pinnacle drawer fronts, Silver pulls	65	5.7	\$813

NOTES: Unit is locking.

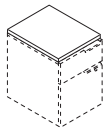

HLSL2016PH2.PNS004	Mobile Pedestal Cushion 15 ⁷ / ₈ "W x 20"D x 1"H for Pedestals Appoint Platinum fabric	6	1.1	\$339
HLSL2016PH2.PNS007	15 ⁷ / ₈ "W x 20"D x 1"H for Pedestals Appoint Jet fabric	6	1.1	\$339
HLSL2016PH2.PNS008	15 ⁷ / ₈ "W x 20"D x 1"H for Pedestals Appoint Carbon fabric	6	1.1	\$339

NOTES:

- File drawers accept hanging folders in letter or legal size.
- Multiple handle locations possible per customer preference.
- Standard box drawers operate on ball-bearing suspension with 70% extension. File drawers operate on ball-bearing suspension with 70% extension.
- Ships with one handle per drawer on all units.

NOW 10500 Series™ Desking

QTY	DESCRIPTION	MODEL	LIST PRICE	PRICE EXTENSION
1	Storage Cabinet with Doors 36"W x 20"D x 29½"H	H105291	\$781	\$781
2	Bookcase Hutch 36"W x 14⅝"D x 37⅞"H	H105292	\$570	\$1,140
1	Lateral File, Two Drawer 36"W x 20"D x 29½"H	H10563	\$973	\$973
1	Single Full Pedestal Desk, Right – B/B/F 72"W x 36"D x 29½"H	H105895R	\$1,361	\$1,361
TOTAL:			\$4,255	

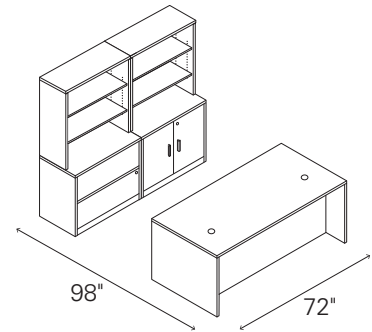

STORAGE WORKSTATION

QTY	DESCRIPTION	MODEL	LIST PRICE	PRICE EXTENSION
1	Double Pedestal Desk 72"W x 36"D x 29½"H	H10593	\$1,391	\$1,391
1	Credenza with Kneespace – B/F 72"W x 24"D x 29½"H	H10543	\$1,240	\$1,240
1	Stack-On Storage, 4 Doors 72"W x 14⅝"D x 37⅞"H	H10534	\$1,011	\$1,011
1	Back Enclosure for Stack-On Storage 69¾"W	H105856	\$237	\$237
TOTAL:			\$3,879	

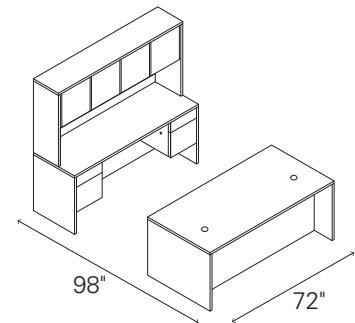

DESK CREDENZA STACK-ON #2

QTY	DESCRIPTION	MODEL	LIST PRICE	PRICE EXTENSION
1	Single Full Pedestal Desk, Right – B/B/F 72"W x 36"D x 29½"H	H105895R	\$1,361	\$1,361
1	Return, Left – F/F 48"W x 24"D x 29½"H	H105906L	\$962	\$962
TOTAL:			\$2,323	

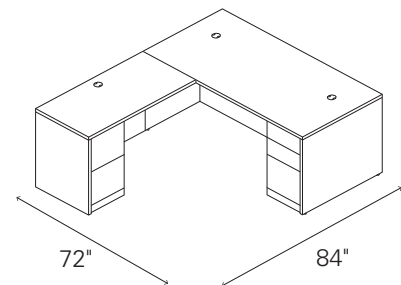

**L-STATION
(RIGHT DESK/LEFT RETURN)**

QTY	DESCRIPTION	MODEL	LIST PRICE	PRICE EXTENSION
1	Single 3/4 Pedestal Desk, Left 66"W x 30"D x 29½"H	H10584L	\$1,039	\$1,039
1	Return, Right 48"W x 24"D x 29½"H	H10515R	\$837	\$837
1	Stack-On Storage, 3 Doors 48"W x 14⅝"D x 37⅞"H	H105323	\$850	\$850
TOTAL:			\$3,048	

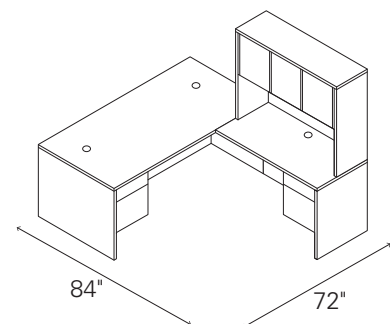

**L-STATION WITH STACK-ON STORAGE
(LEFT DESK/RIGHT RETURN)**

LAMINATE WOOD DESKS — FULL PEDESTALS

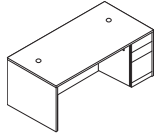

MODEL	DESCRIPTION	FULL WIDTH OVERHANG	SHIP WEIGHT	CUBE	LIST PRICE
H105895R.LFWILFW1	Single Pedestal Desk 72"W x 36"D x 29½"H, Rectangle Top, Right Florence Walnut top and chassis	10½"	278	50.9	\$1361
H105895R.PINCPINC	72"W x 36"D x 29½"H, Rectangle Top, Right Pinnacle top and chassis	10½"	278	50.9	\$1361
H105896L.LFWILFW1	72"W x 36"D x 29½"H, Rectangle Top, Left Florence Walnut top and chassis	10½"	278	50.9	\$1361
H105896L.PINCPINC	72"W x 36"D x 29½"H, Rectangle Top, Left Pinnacle top and chassis	10½"	278	50.9	\$1361

NOTES: Box/box/file drawers. Drawers lock. Two cord grommets in top for routing and hiding wires and cables. Full-to-floor pedestals maximize storage space. Smooth, flat edges provide a clean look.

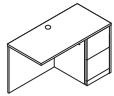

H105905R.LFWILFW1	Return, file/file 48"W x 24"D x 29½"H, Right Florence Walnut top and chassis		167	24.2	\$962
H105905R.PINCPINC	48"W x 24"D x 29½"H, Right Pinnacle top and chassis		167	24.2	\$962
H105906L.LFWILFW1	48"W x 24"D x 29½"H, Left Florence Walnut top and chassis		167	24.2	\$962
H105906L.PINCPINC	48"W x 24"D x 29½"H, Left Pinnacle top and chassis		167	24.2	\$962

NOTES: Return is for use with single pedestal desks, desk shells, peninsulas or corner units. One worksurface grommet and one cord pass-through grommet in top center of modesty panel to reach wall electrical outlets. Drawers lock. Not to be used freestanding. Will not attach to Corner Units manufactured prior to 5/24/99. Formal, full-length modesty panels. 10500 Series™ 18¾"D modular and mobile pedestals can be positioned under credenza with kneespace and single pedestal credenza models.

NOTES:

- Factory-configured desks, credenzas and returns ship fully assembled for ease and speed of installation.
- Tops are easy-care, scratch-, spill- and stain-resistant laminate over 1⅝" solid core high-performance particleboard.
- Drawers operate on full extension, ball-bearing suspensions to ensure smooth, quiet, long-lasting operation.
- File drawer design includes integrated hangrails for side-to-side letter or legal filing; and front-to-back for letter filing.
- All drawers are five-sided construction for added strength and easy alignment or replacement of drawer fronts.

NOW 10500 Series™ Desking

GSA SIN 33721



LAMINATE WOOD DESKS — 3/4 PEDESTALS

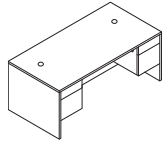

MODEL	DESCRIPTION	FULL WIDTH OVERHANG	SHIP WEIGHT	CUBE	LIST PRICE
H10593.LFW1LFW1	Double Pedestal Desk 72"W x 36"D x 29½"H, Rectangle Top, 2-2 Florence Walnut top and chassis	10½"	320	52.9	\$1391
H10593.PINCPINC	72"W x 36"D x 29½"H, Rectangle Top, 2-2 Pinnacle top and chassis	10½"	320	52.9	\$1391
H10573.LFW1LFW1	60"W x 30"D x 29½"H, Rectangle Top, 2-2 Florence Walnut top and chassis	4½"	271	37.4	\$1172
H10573.PINCPINC	60"W x 30"D x 29½"H, Rectangle Top, 2-2 Pinnacle top and chassis	4½"	271	37.4	\$1172

NOTES: All drawers lock. Two cord grommets in top for routing and hiding wires and cables.

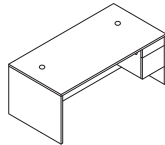

H10583R.LFW1LFW1	Single Pedestal Desk 66"W x 30"D x 29½"H, Rectangle Top, Right Florence Walnut top and chassis	4½"	229	41.0	\$1039
H10583R.PINCPINC	66"W x 30"D x 29½"H, Rectangle Top, Right Pinnacle top and chassis	4½"	229	41.0	\$1039
H10584L.LFW1LFW1	66"W x 30"D x 29½"H, Rectangle Top, Left Florence Walnut top and chassis	4½"	229	41.0	\$1039
H10584L.PINCPINC	66"W x 30"D x 29½"H, Rectangle Top, Left Pinnacle top and chassis	4½"	229	41.0	\$1039

NOTES: Box/file drawers. Drawers lock. Two cord grommets in top for routing and hiding wires and cables.

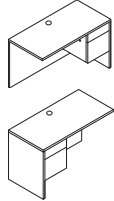

H10515R.LFW1LFW1	Return, box/file 48"W x 24"D x 29½"H, Right Florence Walnut top and chassis		147	25.6	\$837
H10515R.PINCPINC	48"W x 24"D x 29½"H, Right Pinnacle top and chassis		147	25.6	\$837
H10516L.LFW1LFW1	48"W x 24"D x 29½"H, Left Florence Walnut top and chassis		147	25.6	\$837
H10516L.PINCPINC	48"W x 24"D x 29½"H, Left Pinnacle top and chassis		147	25.6	\$837

NOTES: Return is for use with single pedestal desks, desk shells, peninsulas or corner units. One worksurface grommet and one cord pass-through grommet in top center of modesty panel to reach wall electrical outlets. Drawers lock.

⚠ Not designed to be used freestanding. Will not attach to Corner Units manufactured prior to 5/24/99.

NOTES:

- Tops and end panels are abrasion- and stain-resistant laminate over durable 1½" solid core high-performance particleboard; resists warping.
- Formal, full height modesty panels.
- All drawers are 5-sided construction, which allows easy drawer alignment or replacement of drawer fronts.
- Drawers operate on full extension, ball-bearing suspensions to ensure smooth, quiet, long-lasting operation.
- File drawer design includes integrated hangrails for side-to-side letter or legal filing; and front-to-back for letter filing.
- Desk, credenza, and return models ship assembled.



LAMINATE WOOD DESKS — 3/4 PEDESTALS

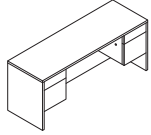

MODEL	DESCRIPTION	FULL WIDTH OVERHANG	SHIP WEIGHT	CUBE	LIST PRICE
H10543.LFW1LFW1	Credenza with Kneespace — box/file 72"W x 24"D x 29½"H Florence Walnut top and chassis	3½"	243	36.3	\$1240
H10543.PINCPINC	72"W x 24"D x 29½"H Pinnacle top and chassis	3½"	243	36.3	\$1240
H10565.LFW1LFW1	60"W x 24"D x 29½"H Florence Walnut top and chassis	3½"	229	28.8	\$1172
H10565.PINCPINC	60"W x 24"D x 29½"H Pinnacle top and chassis	3½"	229	28.8	\$1172

NOTES:

- Tops and end panels are abrasion- and stain-resistant laminate over durable 1/8" solid core high-performance particleboard; resists warping.
- Formal, full height modesty panels.
- All drawers lock. One cord pass-through grommet in top center of modesty panel to reach wall electrical outlets.
- All drawers are 5-sided construction, which allows easy drawer alignment or replacement of drawer fronts.
- Drawers operate on full extension, ball-bearing suspensions to ensure smooth, quiet, long-lasting operation.
- File drawer design includes integrated hangrails for side-to-side letter or legal filing; and front-to-back for letter filing.
- Desk, credenza, and return models ship assembled.

⚠ Not designed to be used with 22¾"D modular or mobile pedestals. Modesty/back panel is inset 3½".

LAMINATE STORAGE

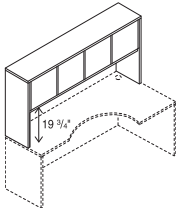

MODEL	DESCRIPTION	SHIP WEIGHT	CUBE	LIST PRICE
H10534.LFW1LFW1	Stack-on Storage 72"W x 14⅝"D x 37⅞"H, 4 doors Florence Walnut top and chassis	185	17.1	\$1011
H10534.PINCPINC	72"W x 14⅝"D x 37⅞"H, 4 doors Pinnacle top and chassis	185	17.1	\$1011
H105324.LFW1LFW1	60"W x 14⅝"D x 37⅞"H, 4 doors Florence Walnut top and chassis	164	14.0	\$943
H105324.PINCPINC	60"W x 14⅝"D x 37⅞"H, 4 doors Pinnacle top and chassis	164	14.0	\$943
H105323.LFW1LFW1	48"W x 14⅝"D x 37⅞"H, 3 doors Florence Walnut top and chassis	141	11.3	\$850
H105323.PINCPINC	48"W x 14⅝"D x 37⅞"H, 3 doors Pinnacle top and chassis	141	11.3	\$850

NOTES: For use on respective desk, credenza or return widths. Rich wood-grain laminate and frosted doors with silver frames adds a contemporary mixed materials option to the 10500 Series™. Stack-on storage models are equipped with self-closing, adjustable hinged doors and valance to hide task light.

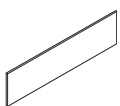

18⅝"H

H105856.LFW1	Back Enclosure for Stack-on Storage 69¾"W - for 72"W model #H10534 Florence Walnut	33	1.3	\$237
H105856.PINC	69¾"W - for 72"W model #H10534 Pinnacle	33	1.3	\$237

NOTES: Non-tackable. When connected to the stack-on storage unit, back enclosure features full-width 1/8" slot at the bottom to facilitate routing cords and reaching wall electrical outlets.

NOW 10500 Series™ Desking

GSA SIN AS NOTED



Icon Legend on page 7

LIGHT ACCESSORIES

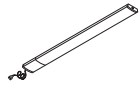

MODEL	DESCRIPTION	SHIP WEIGHT	CUBE	LIST PRICE
HLED31AS	LED Task Lights 31" LED Light with Power Supply (Single)	1.5 ☹	0.09	\$564
HLED17AS	17" LED Light with Power Supply (Single)	1.2 ☹	0.05	\$420

NOTES: No finish specification required. Attaches magnetically to underside of overhead storage, or attaches with provided screws or double-sided tape. Occupancy sensor attaches to a single or starter LED light and will automatically turn the light off after no motion is detected for 30 minutes. Just like all the LED light models, the occupancy sensor features a soft-touch on/off switch. LED task lights have a lifetime of 50,000 hours and have a dimmer feature that allows the user to adjust the amount of light output. Compatible with Systems.

OPEN MARKET

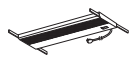

HH870942	Recessed Task Light , 34 ⁵ / ₈ "W x 3 ¹ / ₁₆ "D, for Model H105323 Black finish	10.0 ☹	0.9	\$250
HH870930	Recessed Task Light , 22 ⁷ / ₈ "W x 3 ¹ / ₁₆ "D Black finish	7.0 ☹	0.6	\$231

OPEN MARKET

LAMINATE LATERAL FILES

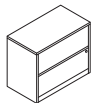

MODEL	DESCRIPTION	SHIP WEIGHT	CUBE	LIST PRICE
H10563.LFWILFW1	Lateral File (with core removable lock) 36"W x 20"D x 29 ¹ / ₂ "H — two drawer Florence Walnut chassis, Florence Walnut drawer fronts	170	15.6	\$973
H10563.PINCPINC	36"W x 20"D x 29 ¹ / ₂ "H — two drawer Pinnacle chassis, Pinnacle drawer fronts	170	15.6	\$973



SIN 33721

NOTES:

- Includes hangrails, mechanical interlock and in H10563, a counterweight.
- Interlock inhibits the extension of more than one drawer from opening at a time.
- Drawers operate on full extension, ball-bearing suspensions to ensure smooth, quiet, long-lasting operation.
- File drawer design includes integrated hangrails for side-to-side letter or legal filing; and front-to-back for letter filing.



LAMINATE BOOKCASES

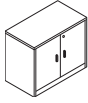

MODEL	DESCRIPTION	SHIP WEIGHT	CUBE	LIST PRICE
H105291.LFW1LFW1	Storage Cabinet with Doors (with core removable lock) 36"W x 20"D x 29½"H Florence Walnut top and chassis	147	15.0	\$781
H105291.PINCPINC	36"W x 20"D x 29½"H Pinnacle top and chassis	147	15.0	\$781

NOTES: Includes one adjustable shelf. Shelf adjusts in ¼" increments with a total range of 5"H. Bookcase hutch (H105292) can be used with H105291.

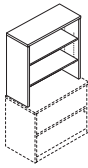

H105292.LFW1LFW1	Bookcase Hutch (for use with lateral file model H10563 and storage cabinet model H105291) 36"W x 14⅝"D x 37⅞"H Florence Walnut	103	3.6	\$570
H105292.PINCPINC	36"W x 14⅝"D x 37⅞"H Pinnacle	103	3.6	\$570

NOTES: Cord pass-through gap behind shelves and a 1⅝"H full-width cord management slot at the bottom of the back panel. Two shelves are adjustable in ¼" increments with a total range of 17½"H.



H105532 shown

H105535.LFW1LFW1	Bookcase 5 Shelf, 36"W x 13⅞"D x 71"H Florence Walnut	187	25.1	\$825
H105535.PINCPINC	5 Shelf, 36"W x 13⅞"D x 71"H Pinnacle	187	25.1	\$825
H105532.LFW1LFW1	2 Shelf, 36"W x 13⅞"D x 29⅝"H Florence Walnut	90	11.0	\$474
H105532.PINCPINC	2 Shelf, 36"W x 13⅞"D x 29⅝"H Pinnacle	90	11.0	\$474

NOTES: Fixed shelves. Inside shelf dimensions on all units is 33¾"W x 12"D x 13"H. No assembly required.

NOW 10500 Series™ Desking

GSA SIN 33721



Icon Legend on page 7

PULL ACCESSORIES

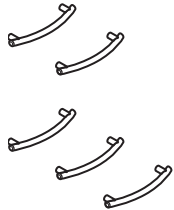

MODEL	DESCRIPTION	SHIP WEIGHT	CUBE	LIST PRICE
	Field Installable Drawer/Door Handle Kits			
HSWEEPA2	Sweep Black finish, 2-pack	0.4 Ⓞ	0.3	\$43
HSWEEPC2	Sweep Satin Nickel finish, 2-pack	0.4 Ⓞ	0.3	\$43
HSWEEPA3	Sweep Black finish, 3-pack	0.5 Ⓞ	0.3	\$56
HSWEEPC3	Sweep Satin Nickel finish, 3-pack	0.5 Ⓞ	0.3	\$56

NOTES: Handles are for purchase and field installation on 10500 Series™ desks, credenzas, returns, and lateral files, as well as for the modular pedestals used with 10500.

Applications include:

- box/file and file/file pedestals = one 2-pack per pedestal
- box/box/file and pencil/media/file pedestals = one 3-pack per pedestal
- two drawer lateral file = two 2-packs per unit
- four drawer lateral file = four 2-packs per unit

The hole spacing for the Sweep and Crescent handles is 96mm (approx. 3¾”).

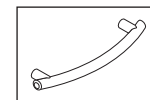

Sweep Handle



MODEL	DESCRIPTION	SHIP WEIGHT	CUBE	LIST PRICE
HBLPBRIDGE	Field Installed Bridge Pull — 2-pack Silver finish	0.4 Ⓞ	0.1	\$12
HBLPCLASSIC	Field Installed Classic Pull — 2-pack Black finish	0.4 Ⓞ	0.1	\$12
HBLPCONTEMP	Field Installed Contemporary Pull — 2-pack Silver finish	0.4 Ⓞ	0.1	\$12

NOTES:

- For use on Lateral Files and Pedestals.
- Can be used as a field-installable alternative to standard Arch pull in Silver finish.
- **HON 5-Year Limited Warranty.**

NOW Workstations Fabrics and Finishes

FABRICS

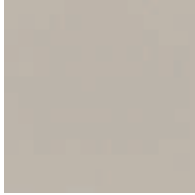

Factor Cascade
FACT25
Accelerate®

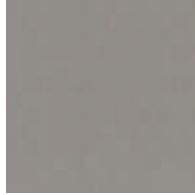

Factor Feather
FACT30
Accelerate®



Appoint Platinum
APN24
Empower®
Pedestal Cushion
& Privacy Screens

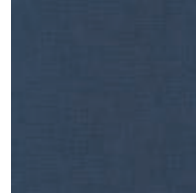

Appoint Jet
APN27
Empower®
Pedestal Cushion
& Privacy Screens

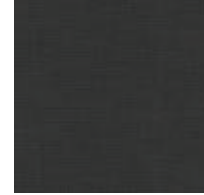

Appoint Carbon
APN28
Empower®
Pedestal Cushion
& Privacy Screens

LAMINATES

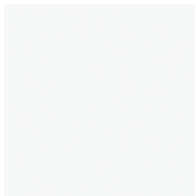

Designer White
LDW1
Accelerate®
Empower®

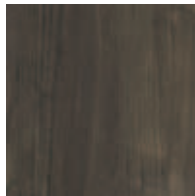

Florence Walnut
LFW1
Accelerate®
Empower®

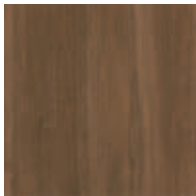

Pinnacle
PINC
Accelerate®
Empower®



Silver Mesh
B9
Accelerate®

PAINT

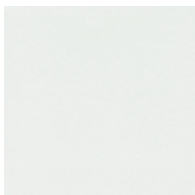

Designer White
PJW
Stationary Empower®

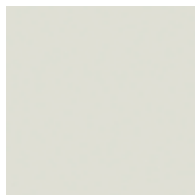

Loft
LOFT
Accelerate®

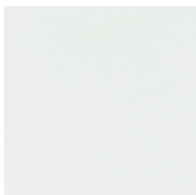

White
PD8
Adjustable Empower®

NOW Accelerate[®] Typical

QTY	DESCRIPTION	MODEL	LIST PRICE	PRICE EXTENSION
2	"T" Connector 42½"H	HEC42PT	\$107	\$214
4	Panel Finished End Covers 42½"H	HEFEC42P	\$54	\$216
4	Tackable Panel 42½"H x 24"W	HETP4224FP	\$295	\$1,180
2	Tackable Panel 42½"H x 36"W	HETP4236FP	\$329	\$658
4	Panel Top Cap 24"W	HETC24	\$38	\$152
2	Panel Top Cap 36"W	HETC36	\$58	\$116
1	Electrical Power Harness 3-1 System 24"W	HH871224	\$206	\$206
2	Electrical Power Harness 3-1 System 36"W	HH871236	\$206	\$412
1	Duplex Receptacle Circuit 1	HH871501	\$42	\$42
1	Duplex Receptacle Circuit 2	HH871502	\$42	\$42
2	Duplex Receptacle Circuit 4	HH871504	\$42	\$84
1	Base In-Feed 72"W	HH879072	\$229	\$229
2	External Channel 48"W	HLZL255C60	\$98	\$196
1	In-Line Connector Kit	HSCKTPS	\$19	\$19
2	Standard Height Freestanding Support Pedestal - B/B/F	HVFB23R	\$556	\$1,112
2	Rectangular Worksurface 72"W x 24"D	HWR2472P	\$529	\$1,058
4	Worksurface Bracket Kit	HWSB2	\$47	\$188
TOTAL:			\$6,124	

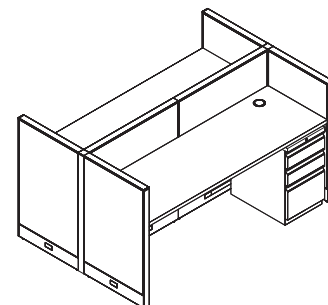

INDIVIDUAL WORKSTATIONS

72"W x 48"D

Shown as a 2-pack.

QTY	DESCRIPTION	MODEL	LIST PRICE	PRICE EXTENSION
4	"L" Connector 65"H	HEC65PL	\$145	\$580
1	"T" Connector 65"H	HEC65PT	\$140	\$140
2	Variable Height Connector Kit 22½"H	HECVH22P	\$67	\$134
2	Panel Finished End Covers 42½"H	HEFEC42P	\$54	\$108
1	Panel Finished End Covers 65"H	HEFEC65P	\$65	\$65
2	Tackable Panel 42½"H x 24"W	HETP4224FP	\$295	\$590
3	Tackable Panel 65"H x 24"W	HETP6524FP	\$351	\$1,053
4	Tackable Panel 65"H x 36"W	HETP6536FP	\$396	\$1,584
2	Tackable Panel 65"H x 48"W	HETP6548FP	\$450	\$900
2	Shelf 5½"H x 13"D x 48"W	HESHRTA48	\$254	\$508
5	Panel Top Cap 24"W	HETC24	\$38	\$190
4	Panel Top Cap 36"W	HETC36	\$58	\$232
2	Panel Top Cap 48"W	HETC48	\$68	\$136
3	Electrical Power Harness 3-1 System 24"W	HH871224	\$206	\$618
2	Electrical Power Harness 3-1 System 48"W	HH871248	\$216	\$432
1	Duplex Receptacle Circuit 1	HH871501	\$42	\$42
1	Duplex Receptacle Circuit 2	HH871502	\$42	\$42
2	Duplex Receptacle Circuit 4	HH871504	\$42	\$84
1	Base In-Feed 72"W	HH879072	\$229	\$229
2	Flat Bracket	HHN831124	\$64	\$128
2	External Channel 60"W	HLZL255C72	\$110	\$220
4	In-Line Connector Kit	HSCKTPS	\$19	\$76
2	Standard Height Freestanding Support Pedestal - B/B/F	HVFB23R	\$556	\$1,112
2	Rectangular Worksurface 48"W x 24"D	HWR2448P	\$404	\$808
2	Rectangular Worksurface 72"W x 24"D	HWR2472P	\$529	\$1,058
5	Worksurface Bracket Kit	HWSB2	\$47	\$235
TOTAL:			\$11,304	

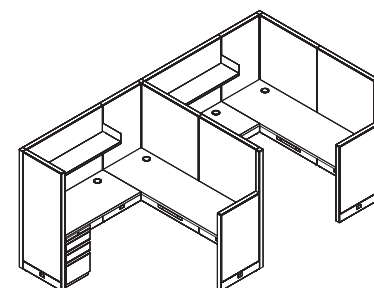

INDIVIDUAL WORKSTATIONS

144"W x 72"D

Shown as a 2-pack.

NOW Accelerate[®] Typicals

QTY	DESCRIPTION	MODEL	LIST PRICE	PRICE EXTENSION
9	Cantilever – One Pair 24”D	HCTL242	\$83	\$747
4	“L” Connector 42½”H	HEC42PL	\$112	\$448
2	“T” Connector 42½”H	HEC42PT	\$107	\$214
1	“X” Connector 42½”H	HEC42PX	\$101	\$101
6	Panel Finished End Covers 42½”H	HEFEC42P	\$54	\$324
6	Tackable Panel 42½”H x 24”W	HETP4224FP	\$295	\$1,770
12	Tackable Panel 42½”H x 36”W	HETP4236FP	\$329	\$3,948
6	Panel Top Cap 24”W	HETC24	\$38	\$228
12	Panel Top Cap 36”W	HETC36	\$58	\$696
1	Electrical Power Harness 3-1 System 24”W	HH871224	\$206	\$206
4	Electrical Power Harness 3-1 System 36”W	HH871236	\$206	\$824
2	Duplex Receptacle Circuit 1	HH871501	\$42	\$84
2	Duplex Receptacle Circuit 2	HH871502	\$42	\$84
4	Duplex Receptacle Circuit 4	HH871504	\$42	\$168
1	Base In-Feed 72”W	HH879072	\$229	\$229
6	In-Line Connector Kit	HSCKTPS	\$19	\$114
4	Standard Height Freestanding Support Pedestal – B/B/F	HVFB23R	\$556	\$2,224
4	Standard Height Freestanding Support Pedestal – F/F	HVFF23R	\$551	\$2,204
4	Corner Worksurface 36”W x 24”D	HWCS3624P	\$522	\$2,088
8	Rectangular Worksurface 36”W x 24”D	HWR2436P	\$346	\$2,768
6	Worksurface Bracket Kit	HWSB2	\$47	\$282
TOTAL:			\$19,751	

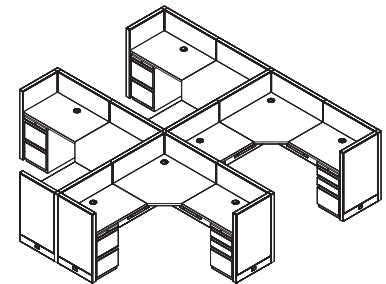

INDIVIDUAL WORKSTATIONS

144”W x 144”D
Shown as a 4-pack.

QTY	DESCRIPTION	MODEL	LIST PRICE	PRICE EXTENSION
4	Adjustable Height Base	HHAB3S2L	\$1,120	\$4,480
2	Cantilever – One Pair 24”D	HCTL242	\$83	\$166
4	“L” Connector 65”H	HEC65PL	\$145	\$580
2	“T” Connector 65”H	HEC65PT	\$140	\$280
1	“X” Connector 65”H	HEC65PX	\$134	\$134
6	Panel Finished End Covers 65”H	HEFEC65P	\$65	\$390
8	Tackable Panel 65”H x 24”W	HETP6524FP	\$351	\$2,808
2	Tackable Panel 65”H x 48”W	HETP6548FP	\$450	\$900
4	Tackable Panel 65”H x 60”W	HETP6560FP	\$480	\$1,920
4	Flipper Door Overhead 15”H x 13”D x 48”W	HEOHRTA1548FD	\$505	\$2,020
8	Panel Top Cap 24”W	HETC24	\$38	\$304
2	Panel Top Cap 48”W	HETC48	\$68	\$136
4	Panel Top Cap 60”W	HETC60	\$84	\$336
3	Electrical Power Harness 3-1 System 24”W	HH871224	\$206	\$618
2	Electrical Power Harness 3-1 System 48”W	HH871248	\$216	\$432
2	Duplex Receptacle Circuit 1 3-1 System	HH871501	\$42	\$84
2	Duplex Receptacle Circuit 2 3-1 System	HH871502	\$42	\$84
4	Duplex Receptacle Circuit 4 3-1 System	HH871504	\$42	\$168
1	Base In-Feed Cable Base 3-1 System	HH879072	\$229	\$229
4	Rectangle Worksurface for Adjustable Height Base 48”W x 24”D	HHAW2448P	\$429	\$1,716
2	Straight Connector Kit	HSCKTPS	\$19	\$38
4	Freestanding Pedestal B/B/F 15”W x 22⅞”D x 28”H	HVFB23R	\$556	\$2,224
4	Rectangle Worksurface w/Grommets 48”W x 24”D	HWR2448P	\$404	\$1,616
2	Worksurface Bracket Kit	HWSB2	\$47	\$94
TOTAL:			\$21,757	

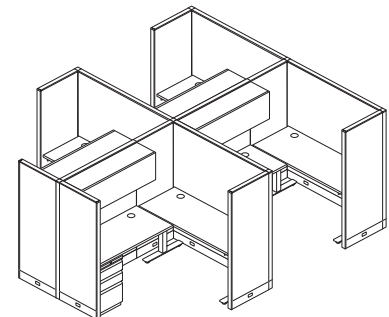

INDIVIDUAL WORKSTATIONS

144”W x 120”D
Shown as a 4-pack with height-adjustable worksurfaces.

NOW Accelerate® Typicals

QTY	DESCRIPTION	MODEL	LIST PRICE	PRICE EXTENSION
4	Standard Height Pedestal B/B/F 15"W x 22 ⁷ / ₈ "D x 28"H	H33723R	\$610	\$2,440
4	Standard Height Pedestal F/F 15"W x 22 ⁷ / ₈ "D x 28"H	H33823R	\$604	\$2,416
8	Cantilever – One Pair 24"D	HCTL242	\$83	\$664
4	"T" Connector 57 ¹ / ₂ "H	HEC57PT	\$133	\$532
1	"X" Connector 57 ¹ / ₂ "H	HEC57PX	\$128	\$128
8	Panel Finished End Covers 57 ¹ / ₂ "H	HEFEC57P	\$61	\$488
8	Tackable Panel 42 ¹ / ₂ "H x 24"W	HETP4224FP	\$295	\$2,360
8	Tackable Panel 42 ¹ / ₂ "H x 36"W	HETP4236FP	\$329	\$2,632
8	Glass Stacker 15"H x 24"W	HES1524G	\$414	\$3,312
8	Glass Stacker 15"H x 36"W	HES1536G	\$495	\$3,960
8	Panel Top Cap 24"W	HETC24	\$38	\$304
8	Panel Top Cap 36"W	HETC36	\$58	\$464
1	Electrical Power Harness 3-1 System 24"W	HH871224	\$206	\$206
4	Electrical Power Harness 3-1 System 36"W	HH871236	\$206	\$824
2	Duplex Receptacle Circuit 1 3-1 System	HH871501	\$42	\$84
2	Duplex Receptacle Circuit 2 3-1 System	HH871502	\$42	\$84
4	Duplex Receptacle Circuit 4 3-1 System	HH871504	\$42	\$168
1	Base In-Feed Cable Base 3-1 System	HH879072	\$229	\$229
4	Straight Connector Kit	HCKTSP	\$19	\$76
4	Corner Worksurface 36"W x 24"D	HWCS3624P	\$522	\$2,088
8	Rectangle Worksurface w/Grommets 36"W x 24"D	HWR2436P	\$346	\$2,768
8	Worksurface Bracket Kit	HWSB2	\$47	\$376
TOTAL:			\$26,603	

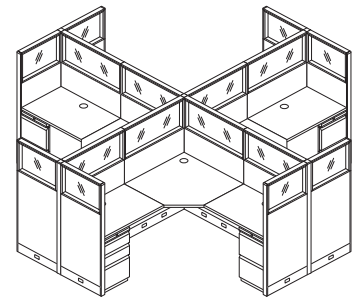

INDIVIDUAL WORKSTATION

144"W x 144"D

Shown as a 4-pack with glass stackers.

QTY	DESCRIPTION	MODEL	LIST PRICE	PRICE EXTENSION
6	Standard Height Pedestal B/B/F 15"W x 22 ⁷ / ₈ "D x 28"H	H33723R	\$610	\$3,660
2	"T" Connector 42 ¹ / ₂ "H	HEC42PT	\$107	\$214
2	"X" Connector 42 ¹ / ₂ "H	HEC42PX	\$101	\$202
8	Panel Finished End Covers 42 ¹ / ₂ "H	HEFEC42P	\$54	\$432
8	Tackable Panel 42 ¹ / ₂ "H x 24"W	HETP4224FP	\$295	\$2,360
3	Tackable Panel 42 ¹ / ₂ "H x 60"W	HETP4260FP	\$415	\$1,245
8	Panel Top Cap 24"W	HETC24	\$38	\$304
3	Panel Top Cap 60"W	HETC60	\$84	\$252
1	Electrical Power Harness 3-1 System 24"W	HH871224	\$206	\$206
3	Electrical Power Harness 3-1 System 60"W	HH871260	\$216	\$648
3	Duplex Receptacle Circuit 1	HH871501	\$42	\$126
3	Duplex Receptacle Circuit 2	HH871502	\$42	\$126
1	Base In-Feed Cable Base	HH879072	\$229	\$229
6	Rectangle Worksurface w/Grommets 60"W x 24"D	HWR2460P	\$477	\$2,862
12	Worksurface Bracket Kit	HWSB2	\$47	\$564
TOTAL:			\$13,530	

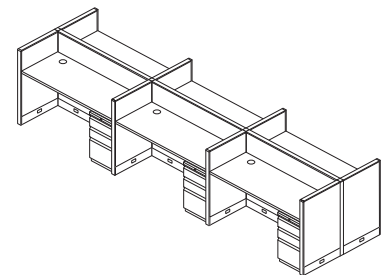

TEAMING

180"W x 48"D

Shown as a 6-pack.

NOW Accelerate® Typicals

QTY	DESCRIPTION	MODEL	LIST PRICE	PRICE EXTENSION
2	Standard Height Pedestal B/B/F 15"W x 22 ⁷ / ₈ "D x 28"H	H33723R	\$610	\$1,220
2	Standard Height Pedestal F/F 15"W x 22 ⁷ / ₈ "D x 28"H	H33823R	\$604	\$1,208
2	"L" Connector 50"H	HEC50PL	\$130	\$260
2	"L" Connector 65"H	HEC65PL	\$145	\$290
1	"T" Connector 65"H	HEC65PT	\$140	\$140
2	Panel Finished End Covers 50"H	HEFEC50P	\$58	\$116
1	Panel Finished End Covers 65"H	HEFEC65P	\$65	\$65
2	Tackable Panel 50"H x 24"W	HETP5024FP	\$331	\$662
2	Tackable Panel 50"H x 48"W	HETP5048FP	\$414	\$828
5	Tackable Panel 65"H x 24"W	HETP6524FP	\$351	\$1,755
2	Tackable Panel 65"H x 48"W	HETP6548FP	\$450	\$900
2	Flipper Door Overhead 15"H x 13"D x 72"W	HEOHRTA1572FD	\$829	\$1,658
7	Panel Top Cap 24"W	HETC24	\$38	\$266
4	Panel Top Cap 48"W	HETC48	\$68	\$272
2	In-Line Variable Height Finishing Kit 15"H	HEVHF15P	\$57	\$114
2	Electrical Power Harness 3-1 System 24"W	HH871224	\$206	\$412
2	Electrical Power Harness 3-1 System 48"W	HH871248	\$216	\$432
2	Duplex Receptacle Circuit 1 3-1 System	HH871501	\$42	\$84
2	Duplex Receptacle Circuit 4 3-1 System	HH871504	\$42	\$84
1	Base In-Feed Cable Base 3-1 System	HH879072	\$229	\$229
2	Flat Bracket 24"D	HHN831124	\$64	\$128
2	Straight Connector Kit	HSCKTPS	\$19	\$38
2	Rectangle Worksurface w/Grommets 48"W x 24"D	HWR2448P	\$404	\$808
2	Rectangle Worksurface w/Grommets 72"W x 24"D	HWR2472P	\$529	\$1,058
6	Worksurface Bracket Kit	HWSB2	\$47	\$282
2	48"W External Channel	HLSLZ5SC60	\$98	\$196
TOTAL:			\$13,505	

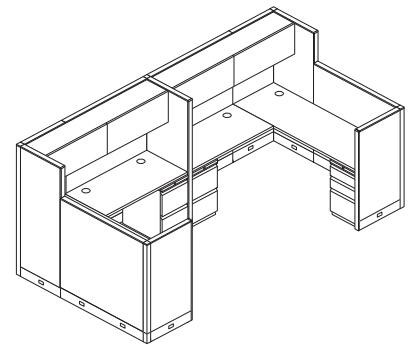

TEAMING WORKSTATION

144"W x 72"D

Shown as a 2-pack.

QTY	DESCRIPTION	MODEL	LIST PRICE	PRICE EXTENSION
4	"L" Connector 57 ¹ / ₂ "H	HEC57PL	\$139	\$556
1	"T" Connector 57 ¹ / ₂ "H	HEC57PT	\$133	\$133
1	Variable Height Connector Kit 15"H	HECVH15P	\$57	\$57
1	Panel Finished End Covers 42 ¹ / ₂ "H	HEFEC42P	\$54	\$54
2	Panel Finished End Covers 57 ¹ / ₂ "H	HEFEC57P	\$61	\$122
5	Tackable Panel 42 ¹ / ₂ "H x 24"W	HETP4224FP	\$295	\$1,475
4	Tackable Panel 42 ¹ / ₂ "H x 36"W	HETP4236FP	\$329	\$1,316
2	Tackable Panel 42 ¹ / ₂ "H x 48"W	HETP4248FP	\$371	\$742
4	Glass Stacker 15"H x 24"W	HES1524G	\$423	\$1,692
4	Glass Stacker 15"H x 36"W	HES1536G	\$495	\$1,980
2	Glass Stacker 15"H x 48"W	HES1548G	\$588	\$1,176
5	Panel Top Cap 24"W	HETC24	\$38	\$190
4	Panel Top Cap 36"W	HETC36	\$58	\$232
2	Panel Top Cap 48"W	HETC48	\$68	\$136
4	Electrical Power Harness 3-1 System 36"W	HH871236	\$206	\$824
2	Duplex Receptacle Circuit 1 3-1 System	HH871501	\$42	\$84
2	Duplex Receptacle Circuit 4 3-1 System	HH871504	\$42	\$84
1	Base In-Feed Cable Base 3-1 System	HH879072	\$229	\$229
2	Flat Bracket 24"D	HHN831124	\$64	\$128
2	External Stiffener 60"W	HLSLZ5SC72	\$110	\$220
4	Straight Connector Kit	HSCKTPS	\$19	\$76
2	Standard Height Freestanding Support Pedestal - F/F	HVFF23R	\$551	\$1,102
2	Rectangle Worksurface w/Grommets 48"W x 24"D	HWR2448P	\$404	\$808
2	Rectangle Worksurface w/Grommets 72"W x 24"D	HWR2472P	\$529	\$1,058
6	Worksurface Bracket Kit	HWSB2	\$47	\$282
TOTAL:			\$14,756	

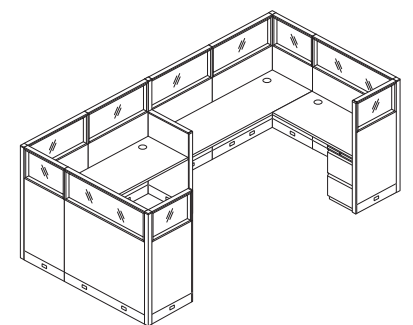

TEAMING WORKSTATION

144"W x 72"D

Shown as a 2-pack with glass stackers.

NOW Accelerate® Reception Typicals

QTY	DESCRIPTION	MODEL	LIST PRICE	PRICE EXTENSION
1	Straight Countertop 72"W	HBCSR1572P	\$406	\$406
2	"L" Connector 42½"H	HEC42PL	\$112	\$224
2	Countertop Bracket - For 42½"H Panels	HECB42	\$53	\$106
2	Panel Finished End Covers 42½"H	HEFEC42P	\$54	\$108
2	Tackable Panel 42½"H x 24"W	HETP4224FP	\$295	\$590
2	Tackable Panel 42½"H x 36"W	HETP4236FP	\$329	\$658
2	Panel Top Cap 24"W	HETC24	\$38	\$76
2	Panel Top Cap 36"W	HETC36	\$58	\$116
1	Electrical Power Harness 3-1 System 24"W	HH871224	\$206	\$206
2	Electrical Power Harness 3-1 System 36"W	HH871236	\$206	\$412
1	Duplex Receptacle Circuit 1	HH871501	\$42	\$42
1	Duplex Receptacle Circuit 4	HH871504	\$42	\$42
1	Base In-Feed 72"W	HH879072	\$229	\$229
1	External Channel 48"W	HLSSL25SC60	\$98	\$98
1	In-Line Connector Kit	HCKTTPS	\$19	\$19
1	Standard Height Freestanding Support Pedestal - B/B/F	HVFB23R	\$556	\$556
1	Rectangular Worksurface 72"W x 24"D	HWR2472P	\$529	\$529
2	Worksurface Bracket Kit	HWSB2	\$47	\$94
TOTAL:			\$4,511	

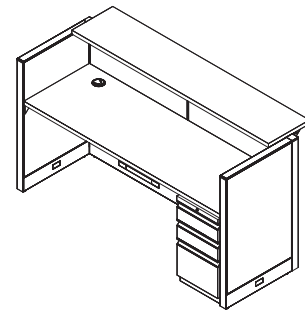

RECEPTION
72"W x 24"D
42"H Panels

QTY	DESCRIPTION	MODEL	LIST PRICE	PRICE EXTENSION
1	Straight Countertop 72"W	HBCSR1572P	\$406	\$406
2	"L" Connector 42½"H	HEC42PL	\$112	\$224
2	"L" Connector 65"H	HEC65PL	\$145	\$290
2	Countertop Bracket - For 42½"H Panels	HECB42	\$53	\$106
1	Panel Finished End Covers 42½"H	HEFEC42P	\$54	\$54
1	Panel Finished End Covers 65"H	HEFEC65P	\$65	\$65
2	Tackable Panel 42½"H x 24"W	HETP4224FP	\$295	\$590
2	Tackable Panel 42½"H x 36"W	HETP4236FP	\$329	\$658
1	Tackable Panel 42½"H x 48"W	HETP4248FP	\$371	\$371
2	Tackable Panel 65"H x 24"W	HETP6524FP	\$351	\$702
2	Tackable Panel 65"H x 36"W	HETP6536FP	\$396	\$792
2	Shelf 5½"H x 13"D x 36"W	HESHRTA36	\$233	\$466
4	Panel Top Cap 24"W	HETC24	\$38	\$152
4	Panel Top Cap 36"W	HETC36	\$58	\$232
1	Panel Top Cap 48"W	HETC48	\$68	\$68
1	In-Line Variable Height Finishing Kit 22½"H	HEVHF22P	\$67	\$67
1	Electrical Power Harness 3-1 System 24"W	HH871224	\$206	\$206
2	Electrical Power Harness 3-1 System 36"W	HH871236	\$206	\$412
1	Electrical Power Harness 3-1 System 48"W	HH871248	\$216	\$216
1	Duplex Receptacle Circuit 1	HH871501	\$42	\$42
1	Duplex Receptacle Circuit 2	HH871502	\$42	\$42
1	Duplex Receptacle Circuit 4	HH871504	\$42	\$42
1	Base In-Feed 72"W	HH879072	\$229	\$229
2	Flat Bracket	HHN831124	\$64	\$128
2	External Channel 48"W	HLSSL25SC66	\$101	\$202
3	In-Line Connector Kit	HCKTTPS	\$19	\$57
1	Standard Height Freestanding Support Pedestal - B/B/F	HVFB23R	\$556	\$556
1	Standard Height Freestanding Support Pedestal - F/F	HVFF23R	\$551	\$551
1	Rectangular Worksurface 48"W x 24"D	HWR2448P	\$404	\$404
2	Rectangular Worksurface 72"W x 24"D	HWR2472P	\$529	\$1,058
4	Worksurface Bracket Kit	HWSB2	\$47	\$188
TOTAL:			\$9,576	

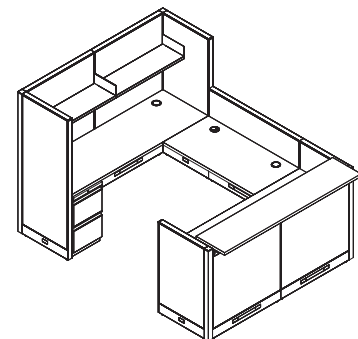

RECEPTION
72"W x 96"D

NOW Accelerate® Reception Typicals

QTY	DESCRIPTION	MODEL	LIST PRICE	PRICE EXTENSION
2	Accessory Cantilever Kit	HCTL242	\$83	\$166
3	"L" Connector 42½"H	HEC42PL	\$112	\$336
2	Panel Finished End Covers 42½"H	HEFEC42P	\$54	\$108
2	Tackable Panel 42½"H x 24"W	HETP4224FP	\$295	\$590
4	Tackable Panel 42½"H x 36"W	HETP4236FP	\$329	\$1,316
2	Panel Top Cap 24"W	HETC24	\$38	\$76
4	Panel Top Cap 36"W	HETC36	\$58	\$232
1	Power Harness w/Duplex Capacity - For 24"W	HH871224	\$206	\$206
2	Power Harness w/Duplex Capacity - For 36"W	HH871236	\$206	\$412
1	Circuit 1	HH871501	\$42	\$42
1	Circuit 4	HH871504	\$42	\$42
1	Base In-Feed 72"	HH879072	\$229	\$229
2	In-Line Connector Kit	HSCKTPS	\$19	\$38
1	Standard Height Freestanding Support Pedestal - B/B/F	HVFB23R	\$556	\$556
1	Standard Height Freestanding Support Pedestal - F/F	HVFF23R	\$551	\$551
1	Corner Worksurface 36"W x 24"D	HWCS3624P	\$522	\$522
2	Rectangular Worksurface 36"W x 24"D	HWR2436P	\$346	\$692
2	Worksurface Bracket Kit	HWSB2	\$47	\$94
TOTAL:				\$6,208

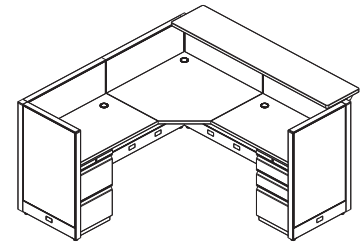

RECEPTION
72"W x 72"D

QTY	DESCRIPTION	MODEL	LIST PRICE	PRICE EXTENSION
1	2 Drawer Lateral File 36"W	H882	\$882	\$882
1	Straight Countertop 72"W	HBCSR1572P	\$406	\$406
2	"L" Connector 42½"H	HEC42PL	\$112	\$224
2	"L" Connector 65"H	HEC65PL	\$145	\$290
2	Countertop Bracket - For 42½"H Panels	HECB42	\$53	\$106
1	Panel Finished End Covers 42½"H	HEFEC42P	\$54	\$54
1	Panel Finished End Covers 65"H	HEFEC65P	\$65	\$65
2	Tackable Panel 42½"H x 24"W	HETP4224FP	\$295	\$590
2	Tackable Panel 42½"H x 36"W	HETP4236FP	\$329	\$658
1	Tackable Panel 42½"H x 48"W	HETP4248FP	\$371	\$371
2	Tackable Panel 65"H x 24"W	HETP6524FP	\$351	\$702
2	Tackable Panel 65"H x 36"W	HETP6536FP	\$396	\$792
1	Panel Top Cap 48"W	HETC48	\$68	\$68
1	In-Line Variable Height Finishing Kit 22½"H	HEVHF22P	\$67	\$67
1	Electrical Power Harness 3-1 System 24"W	HH871224	\$206	\$206
2	Electrical Power Harness 3-1 System 36"W	HH871236	\$206	\$412
1	Electrical Power Harness 3-1 System 48"W	HH871248	\$216	\$216
1	Duplex Receptacle Circuit 1	HH871501	\$42	\$42
1	Duplex Receptacle Circuit 2	HH871502	\$42	\$42
1	Duplex Receptacle Circuit 4	HH871504	\$42	\$42
1	Base In-Feed 72"	HH879072	\$229	\$229
2	Flat Bracket	HHN831124	\$64	\$128
1	External Channel 48"W	HLSSLZ55SC60	\$98	\$98
3	In-Line Connector Kit	HSCKTPS	\$19	\$57
1	Standard Height Freestanding Support Pedestal - B/B/F	HVFB23R	\$556	\$556
1	Rectangular Worksurface 48"W x 24"D	HWR2448P	\$404	\$404
2	Rectangular Worksurface 72"W x 24"D	HWR2472P	\$529	\$1,058
4	Worksurface Bracket Kit	HWSB2	\$47	\$188
2	Panel Top Cap 24"W	HETC24	\$38	\$76
4	Panel Top Cap 36"W	HETC36	\$58	\$232
TOTAL:				\$9,261

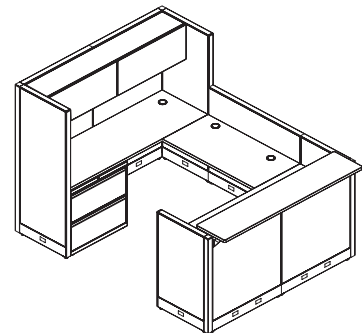

RECEPTION
72"W x 96"D



TACKABLE RACEWAY PANELS

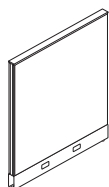

MODEL	DESCRIPTION	SHIP WEIGHT	CUBE	LIST PRICE
HETP4224FP.FACT25.LOFT	42½”H Tackable Acoustical Panels 42½”H x 24”W Factor Cascade fabric, Loft trim	16	1.5	\$295
HETP4224FP.FACT30.LOFT	42½”H x 24”W Factor Feather fabric, Loft trim	16	1.5	\$295
HETP4230FP.FACT25.LOFT	42½”H x 30”W Factor Cascade fabric, Loft trim	18	1.8	\$313
HETP4230FP.FACT30.LOFT	42½”H x 30”W Factor Feather fabric, Loft trim	18	1.8	\$313
HETP4236FP.FACT25.LOFT	42½”H x 36”W Factor Cascade fabric, Loft trim	20	2.2	\$329
HETP4236FP.FACT30.LOFT	42½”H x 36”W Factor Feather fabric, Loft trim	20	2.2	\$329
HETP4248FP.FACT25.LOFT	42½”H x 48”W Factor Cascade fabric, Loft trim	25	3.0	\$371
HETP4248FP.FACT30.LOFT	42½”H x 48”W Factor Feather fabric, Loft trim	25	3.0	\$371
HETP4260FP.FACT25.LOFT	42½”H x 60”W Factor Cascade fabric, Loft trim	30	3.7	\$415
HETP4260FP.FACT30.LOFT	42½”H x 60”W Factor Feather fabric, Loft trim	30	3.7	\$415

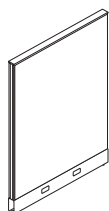

HETP5024FP.FACT25.LOFT	50”H Tackable Acoustical Panels 50”H x 24”W Factor Cascade fabric, Loft trim	17	1.7	\$337
HETP5024FP.FACT30.LOFT	50”H x 24”W Factor Feather fabric, Loft trim	17	1.7	\$337
HETP5030FP.FACT25.LOFT	50”H x 30”W Factor Cascade fabric, Loft trim	20	2.2	\$346
HETP5030FP.FACT30.LOFT	50”H x 30”W Factor Feather fabric, Loft trim	20	2.2	\$346
HETP5036FP.FACT25.LOFT	50”H x 36”W Factor Cascade fabric, Loft trim	22	2.6	\$357
HETP5036FP.FACT30.LOFT	50”H x 36”W Factor Feather fabric, Loft trim	22	2.6	\$357
HETP5048FP.FACT25.LOFT	50”H x 48”W Factor Cascade fabric, Loft trim	28	3.5	\$423
HETP5048FP.FACT30.LOFT	50”H x 48”W Factor Feather fabric, Loft trim	28	3.5	\$423
HETP5060FP.FACT25.LOFT	50”H x 60”W Factor Cascade fabric, Loft trim	32	4.3	\$462
HETP5060FP.FACT30.LOFT	50”H x 60”W Factor Feather fabric, Loft trim	32	4.3	\$462

NOTES:

- Panels are 2½” thick.
 - Baseraills ship standard with panels.
 - Packaging: stretch wrapped with edge protection.
 - Base rail matches trim color.
 - Panels have a class A fire rating.
 - Bulk packing is available in quantities of 3 or 9.
 - Panel stability will be increased by tying panels to worksurfaces or storage.
- Raceway panels option only.
 - If adding to existing panels produced prior to 04/13/16, please contact Customer Support for compatibility.
 - Top caps ordered separately.



TACKABLE RACEWAY PANELS

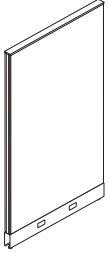

MODEL	DESCRIPTION	SHIP WEIGHT	CUBE	LIST PRICE
HETP6524FP.FACT25.LOFT	65"H Tackable Acoustical Panels 65"H x 24"W Factor Cascade fabric, Loft trim	20 ☹	2.3	\$358
HETP6524FP.FACT30.LOFT	65"H x 24"W Factor Feather fabric, Loft trim	20 ☹	2.3	\$358
HETP6530FP.FACT25.LOFT	65"H x 30"W Factor Cascade fabric, Loft trim	23 ☹	2.8	\$377
HETP6530FP.FACT30.LOFT	65"H x 30"W Factor Feather fabric, Loft trim	23 ☹	2.8	\$377
HETP6536FP.FACT25.LOFT	65"H x 36"W Factor Cascade fabric, Loft trim	26 ☹	3.4	\$404
HETP6536FP.FACT30.LOFT	65"H x 36"W Factor Feather fabric, Loft trim	26 ☹	3.4	\$404
HETP6548FP.FACT25.LOFT	65"H x 48"W Factor Cascade fabric, Loft trim	32 ☹	4.5	\$459
HETP6548FP.FACT30.LOFT	65"H x 48"W Factor Feather fabric, Loft trim	32 ☹	4.5	\$459
HETP6560FP.FACT25.LOFT	65"H x 60"W Factor Cascade fabric, Loft trim	37	5.6	\$490
HETP6560FP.FACT30.LOFT	65"H x 60"W Factor Feather fabric, Loft trim	37	5.6	\$490

NOTES:

- Panels are 2½" thick.
- Baseraills ship standard with panels.
- Packaging: stretch wrapped with edge protection.
- Base rail matches trim color.
- Panels have a class A fire rating.
- Bulk packing is available in quantities of 3 or 9.
- Panel stability will be increased by tying panels to worksurfaces or storage.

! Raceway panels option only.

! If adding to existing panels produced prior to 04/13/16, please contact Customer Support for compatibility.

! Top caps ordered separately.









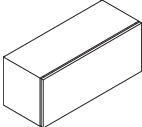

NOW Accelerate® Workstations

GSA SIN 33721 EXCEPT AS NOTED

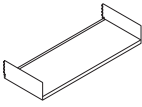

Icon Legend on page 7





ETA OVERHEADS AND SHELVES

	MODEL	DESCRIPTION	SHIP WEIGHT	CUBE	LIST PRICE
	HEOHRTA1530FD.LOFT	Flipper Door Overheads 30"W x 13"D x 15"H Loft paint	24 	1.6	\$441
	HEOHRTA1536FD.LOFT	36"W x 13"D x 15"H Loft paint	27 	1.6	\$463
	HEOHRTA1548FD.LOFT	48"W x 13"D x 15"H Loft paint	33 	2.1	\$505
	HEOHRTA1560FD.LOFT	60"W x 13"D x 15"H Loft paint	42 	2.5	\$667
	HEOHRTA1572FD.LOFT	72"W x 13"D x 15"H Loft paint	49 	3.0	\$829
	HESHRTA30.LOFT	Open Shelves 30"W x 13"D x 5 5/8"H Loft paint	11 	1.9	\$219
	HESHRTA36.LOFT	36"W x 13"D x 5 5/8"H Loft paint	12 	1.9	\$233
	HESHRTA48.LOFT	48"W x 13"D x 5 5/8"H Loft paint	14 	2.4	\$254
	HESHRTA60.LOFT	60"W x 13"D x 5 5/8"H Loft paint	16 	3.0	\$309

NOTES:

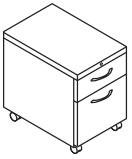
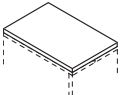
- Storage Cabinets with doors are standard with a factory installed core removable lock located on the underside of the cabinet.
 - All units feature an anti-dislodgement device.
 - Accepts under cabinet lighting.
 - ETA overheads and shelves ship flat packed.
 - Only one installer is needed to assemble an ETA overhead on a panel (all sizes).
 - Attachment brackets are attached to the back of the unit (included).
 - ETA overheads and shelves are slightly less deep than built-up models. Please note when using next to built-up models.
 - Order overhead and shelf to match the width of panel being used.
-  Cannot be used in off-modular applications because attachment bracket is attached to the back of the case and cannot be moved.

MOBILE PEDESTALS

	MODEL	DESCRIPTION	SHIP WEIGHT	CUBE	LIST PRICE
	H15923A.L.LOFT	Mobile Pedestals — Box/File 15"W x 22 7/8"D x 22"H <i>For Accelerate® Workstations</i> Satin Chrome Arch pull, Lock, Loft paint	92	6.0	\$569
	NOTES: Pencil tray standard in top box drawer. One box divider standard in each box drawer. One crossrail standard in each file drawer. File drawers have high sides for filing front-to-back. Steel ball-bearing suspension on file drawer, and box drawer. Equipped with HON "One Key" interchangeable core removable locks. Counterweight standard.				
	HPSEAT24ND.PNS007	Pedestal Seat 15"W x 22 7/8"D x 2"H Appoint Jet fabric	10 	1.2	\$224
	HPSEAT24ND.PNS008	15"W x 22 7/8"D x 2"H Appoint Carbon fabric	10 	1.2	\$224
	HPSEAT24ND.PNS004	15"W x 22 7/8"D x 2"H Appoint Platinum fabric	10 	1.2	\$224

  OPEN MARKET

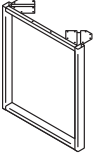

WORKSURFACE SUPPORTS

	MODEL	DESCRIPTION	SHIP WEIGHT	CUBE	LIST PRICE
	HLSLPBL.LOFT	28½”H O-Leg-to-Accelerate® Panel Attachment Bracket 28½”H Left handed bracket (quantity 1) Loft paint	3 Ⓔ	0.4	\$100
	HLSLPBR.LOFT	28½”H Right handed bracket (quantity 1) Loft paint	3 Ⓔ	0.4	\$100
<p>NOTES: Used to connect Voi O-Leg to a systems panel for additional workstation rigidity. Bracket designed to work with edgeband worksurfaces only. Brackets are handed, come one per package and include self-tapping screws. Shared O-Legs create a cleaner aesthetic in all applications where two legs are used side-by-side. The bracket on the O-leg will span both worksurfaces to provide the same support with the look of a single O-leg. Will have a 6” overhang when using 30” worksurface supports with a 36”D worksurface.</p>					
	HLSL24280.LOFT	O-Leg Support for Worksurfaces 24”D x 28½”H Loft paint	17	3.7	\$324
	HLSL24280.PR6	24”D x 28½”H Silver paint	17	3.7	\$328
	HLSL24280.PJW	24”D x 28½”H Designer White paint	17	3.7	\$324
	HLSL30280.PJW	30”D x 28½”H Designer White paint	19	5.4	\$359
	HLSL30280.PR6	30”D x 28½”H Silver paint	19	5.4	\$363
<p>NOTES: Ship fully assembled, 1/pack. Non-handed.</p>					

NOTES:

- A variety of pedestals, end panels, and O-legs can be combined to create a conventional or contemporary desk.
- O-leg ships fully assembled with mounting hardware.
- Glides on O-Leg Support for Worksurfaces and Post Leg Base have 2” of adjustability. No glides on 7”H O-leg. Glides on end panels have 1¼” adjustability.

! O-legs may only be attached to worksurfaces, not storage units.

NOW Accelerate® Workstations

GSA SIN 33721



Icon Legend on page 7

TOP CAPS

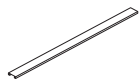

MODEL	DESCRIPTION	SHIP WEIGHT	CUBE	LIST PRICE
	Panel Top Cap			
HETC24.LOFT	24"W Loft paint	1.6	0.3	\$38
HETC30.LOFT	30"W Loft paint	1.8	0.3	\$46
HETC36.LOFT	36"W Loft paint	2.0	0.3	\$58
HETC48.LOFT	48"W Loft paint	3.4	0.4	\$68
HETC60.LOFT	60"W Loft paint	3.9	0.6	\$84

NOTES:

- Top caps ship separately from panels.
 - Top caps are able to span multiple panels for a clean aesthetic.
 - Top caps are bulk packed for ease at installation sites.
- ! If adding to existing panels produced prior to 04/13/16, please contact Customer Support for compatibility.

STACKING PANELS

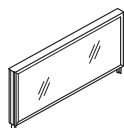







MODEL	DESCRIPTION	SHIP WEIGHT	CUBE	CLEAR GLASS
	15"H Stacking Panels — Glass			
HES1524G.LOFT.Q	15"H x 24"W Loft paint, Clear glass	9 Ⓢ	0.6	\$423
HES1530G.LOFT.Q	15"H x 30"W Loft paint, Clear glass	11 Ⓢ	0.8	\$477
HES1536G.LOFT.Q	15"H x 36"W Loft paint, Clear glass	12 Ⓢ	0.9	\$495
HES1548G.LOFT.Q	15"H x 48"W Loft paint, Clear glass	16 Ⓢ	1.2	\$588
HES1560G.LOFT.Q	15"H x 60"W Loft paint, Clear glass	19 Ⓢ	1.5	\$673

NOTES:

- Stacking panels ship without top caps.
 - Stackers add 15" or 30" to the height of the base panel.
 - Stacker ships with pins to connect stacker to post connector for added rigidity.
- ! Not to be used freestanding.
- ! Stackers can be stacked up to 80"H on a base panel or 30" of stacker height total, whichever comes first.
- ! The first stacker on a base panel is weight bearing and can accommodate overhead storage up to 65"H.
- ! Stacking model must match the width of the panel it is stacking on.
- ! Total panel height cannot exceed 80" high. Glass stacker must be the top tier. A stacking panel cannot be placed above a glass panel or glass stacker. Frameless Glass can be installed on a fabric stacker.
- ! If adding to existing panels produced prior to 04/13/16, please contact Customer Support for compatibility.

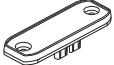

CONNECTORS

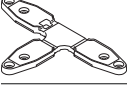
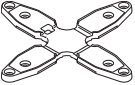
	MODEL	DESCRIPTION	SHIP WEIGHT	CUBE	LIST PRICE
	HEC42PLN.LOFT	"L" Connector For 42½"H Panels Loft paint	6.0 Ⓞ	0.5	\$112
	HEC50PLN.LOFT	For 50"H Panels Loft paint	7.0 Ⓞ	0.6	\$130
	HEC57PLN.LOFT	For 57"H Panels Loft paint	8.0 Ⓞ	0.6	\$139
	HEC65PLN.LOFT	For 65"H Panels Loft paint	8.0 Ⓞ	0.7	\$145
	HEC42PTN.LOFT	"T" Connector For 42½"H Panels Loft paint	6.0 Ⓞ	0.5	\$107
	HEC50PTN.LOFT	For 50"H Panels Loft paint	7.0 Ⓞ	0.6	\$125
	HEC57PTN.LOFT	For 57"H Panels Loft paint	8.0 Ⓞ	0.6	\$133
	HEC65PTN.LOFT	For 65"H Panels Loft paint	8.0 Ⓞ	0.7	\$140
	HEC42PXN.LOFT	"X" Connector For 42½"H Panels Loft paint	6.0 Ⓞ	0.5	\$101
	HEC50PXN.LOFT	For 50"H Panels Loft paint	7.0 Ⓞ	0.6	\$120
	HEC57PXN.LOFT	For 57"H Panels Loft paint	8.0 Ⓞ	0.6	\$128
	HEC65PXN.LOFT	For 65"H Panels Loft paint	8.0 Ⓞ	0.7	\$134
	HECSI	Single Connector Strap	1.9 Ⓞ	0.2	\$16
	HCKTPS.X	In-line Connector	0.5	0.1	\$19
	HECSL	"L" Connector Strap	1.5 Ⓞ	0.2	\$16
	HECST	"T" Connector Strap	2.3 Ⓞ	0.2	\$21
	HECSX	"X" Connector Strap	3.0 Ⓞ	0.2	\$26



















NOTES:

- Specify connectors based on number and placement of panels.
- Connectors ship complete with all hardware necessary to complete connection.
- Specify connector to fit height of tallest panel.
- Connectors are made of extruded aluminum.
- Straight Connector model HCKTPS ships standard in bulk pack.

! In-line connector must be specified for all in-line connections.

! If adding to existing panels produced prior to 04/13/16, please contact Customer Support for compatibility.

VARIABLE HEIGHT FINISHED END AND WALL STARTER KITS

	MODEL	DESCRIPTION	SHIP WEIGHT	CUBE	LIST PRICE
		Finished End Covers			
	HEFEC42P.LOFT	42½"H Loft paint	3 	0.5	\$54
	HEFEC50P.LOFT	50"H Loft paint	4 	0.6	\$58
	HEFEC57P.LOFT	57½"H Loft paint	5 	0.6	\$61
	HEFEC65P.LOFT	65"H Loft paint	5 	0.7	\$65
	NOTES: Finished End Covers include top bracket, end trim clips and end trim.				
		In-line Variable Height Finishing Kit			
	HEVHF07P.LOFT	7½"H Loft paint	2 	0.2	\$53
	HEVHF15P.LOFT	15"H Loft paint	2 	0.4	\$57
	HEVHF22P.LOFT	22½"H Loft paint	3 	0.4	\$67
	NOTES: In-line Variable Height Finishing Kits include top and bottom bracket, end trim clips and end trim. In-line Variable Height Finishing Kit is used to connect a finished in-line panel connection.				
		Connector Variable Height Finishing Kit			
	HECVH07P.LOFT	7½"H Loft paint	2 	0.2	\$53
	HECVH15P.LOFT	15"H Loft paint	2 	0.4	\$57
	HECVH22P.LOFT	22½"H Loft paint	3 	0.4	\$67
	NOTES: Connector Variable Height Finishing Kits include top and bottom bracket, end trim and end trim connection piece.				
		Wall Starter Kit			
	HEWS42P.LOFT	42½"H Loft paint	4 	0.5	\$91
	HEWS50P.LOFT	50"H Loft paint	5 	0.6	\$95
	HEWS57P.LOFT	57½"H Loft paint	6 	0.6	\$100
	HEWS65P.LOFT	65"H Loft paint	6 	0.7	\$107

NOTES:

- In-line Variable Height Finishing Kit is used to connect a finished in-line panel connection.
- Connector variable height finishing kit is used at a drop in height at an L, T, X, or S connection.
- All kits come with all hardware needed to install the kit.

- ! Variable height kit needs to be specified any time a change of panel height occurs.
- ! Finished end covers must be specified at all end of panel runs.
- ! If adding to existing panels produced prior to 04/13/16, please contact Customer Support for compatibility.



PRIMARY WORKSURFACES

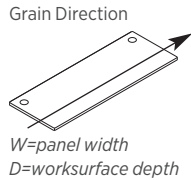

MODEL	DESCRIPTION	SHIP WEIGHT	CUBE	LIST PRICE
	Primary and/or Return Worksurfaces			
HWR2430P.B9.LOFT.LOFT	30"W x 24"D Silver Mesh laminate, Loft edge, Loft grommet	37	2.2	\$320
HWR2430P.PINC.PINC.LOFT	30"W x 24"D Pinnacle laminate and edge, Loft grommet	37	2.2	\$320
HWR2430P.LFW1.FW.LOFT	30"W x 24"D Florence Walnut and edge, Loft grommet	37	2.2	\$320
HWR2430P.LDW1.DW.LOFT	30"W x 24"D Designer White laminate and edge, Loft grommet	37	2.2	\$320
HWR2436P.B9.LOFT.LOFT	36"W x 24"D Silver Mesh laminate, Loft edge, Loft grommet	46	2.5	\$346
HWR2436P.PINC.PINC.LOFT	36"W x 24"D Pinnacle laminate and edge, Loft grommet	46	2.5	\$346
HWR2436P.LFW1.FW.LOFT	36"W x 24"D Florence Walnut and edge, Loft grommet	46	2.5	\$346
HWR2436P.LDW1.DW.LOFT	36"W x 24"D Designer White laminate and edge, Loft grommet	46	2.5	\$346
HWR2448P.B9.LOFT.LOFT	48"W x 24"D Silver Mesh laminate, Loft edge, Loft grommet	58	3.3	\$404
HWR2448P.PINC.PINC.LOFT	48"W x 24"D Pinnacle laminate and edge, Loft grommet	58	3.3	\$404
HWR2448P.LFW1.FW.LOFT	48"W x 24"D Florence Walnut and edge, Loft grommet	58	3.3	\$404
HWR2448P.LDW1.DW.LOFT	48"W x 24"D Designer White laminate and edge, Loft grommet	58	3.3	\$404
HWR2460P.B9.LOFT.LOFT	60"W x 24"D Silver Mesh laminate, Loft edge, Loft grommet	70	4.0	\$477
HWR2460P.PINC.PINC.LOFT	60"W x 24"D Pinnacle laminate and edge, Loft grommet	70	4.0	\$477
HWR2460P.LFW1.FW.LOFT	60"W x 24"D Florence Walnut and edge, Loft grommet	70	4.0	\$477
HWR2460P.LDW1.DW.LOFT	60"W x 24"D Designer White laminate and edge, Loft grommet	70	4.0	\$477
HWR2472P.B9.LOFT.LOFT	72"W x 24"D Silver Mesh laminate, Loft edge, Loft grommet	89	4.8	\$529
HWR2472P.PINC.PINC.LOFT	72"W x 24"D Pinnacle laminate and edge, Loft grommet	89	4.8	\$529
HWR2472P.LFW1.FW.LOFT	72"W x 24"D Florence Walnut and edge, Loft grommet	89	4.8	\$529
HWR2472P.LDW1.DW.LOFT	72"W x 24"D Designer White laminate and edge, Loft grommet	89	4.8	\$529
HWR3048P.LDW1.DW.DW	48"W x 30"D Designer White laminate, edge, and grommet	68	4.0	\$436
HWR3060P.B9.LOFT.LOFT	60"W x 30"D Silver Mesh laminate, Loft edge, Loft grommet	101	5.0	\$520
HWR3060P.PINC.PINC.LOFT	60"W x 30"D Pinnacle laminate and edge, Loft grommet	101	5.0	\$520
HWR3060P.LFW1.FW.LOFT	60"W x 30"D Florence Walnut and edge, Loft grommet	101	5.0	\$520
HWR3060P.LDW1.DW.LOFT	60"W x 30"D Designer White laminate and edge, Loft grommet	101	5.0	\$520
HWR3072P.B9.LOFT.LOFT	72"W x 30"D Silver Mesh laminate, Loft edge, Loft grommet	105	6.0	\$593
HWR3072P.PINC.PINC.LOFT	72"W x 30"D Pinnacle laminate and edge, Loft grommet	105	6.0	\$593
HWR3072P.LFW1.FW.LOFT	72"W x 30"D Florence Walnut and edge, Loft grommet	105	6.0	\$593
HWR3072P.LDW1.DW.LOFT	72"W x 30"D Designer White laminate and edge, Loft grommet	105	6.0	\$593

NOTES:

- Worksurfaces are constructed of laminate on 1/4" solid core high-performance particleboard.
- Models up to 42"W are standard with one centered grommet. Models 48"W and wider are standard with two grommets.
- Woodgrain runs horizontally across surface.
- ! 60"W, 66"W and 72"W worksurfaces require one or more of the following: worksurface support brackets, end panel, external channel universal support leg or pedestal support in conjunction with cantilever brackets.
- ! When a run of worksurfaces equals or exceeds 6 feet, a floor support is required for worksurface structural assurance.
- ! All worksurfaces load tested to BIFMA standards.

CORNER WORKSURFACES

Grain Direction

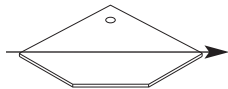

W=panel width
D=worksurface depth

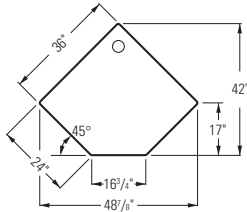

HWCS3624P

MODEL	DESCRIPTION	SHIP WEIGHT	CUBE	LIST PRICE
Corner Worksurfaces with Straight User Edge				
HWCS3624P.B9.LOFT.LOFT	36"W x 24"D Silver Mesh laminate, Loft edge, Loft grommet	53 Ⓢ	3.7	\$522
HWCS3624P.PINC.PINC.LOFT	36"W x 24"D Pinnacle laminate and edge, Loft grommet	53 Ⓢ	3.7	\$522
HWCS3624P.LFW1.FW.LOFT	36"W x 24"D Florence Walnut laminate and edge, Loft grommet	53 Ⓢ	3.7	\$522
HWCS3624P.LDW1.DW.LOFT	36"W x 24"D Designer White laminate and edge, Loft grommet	53 Ⓢ	3.7	\$522

NOTES:

- Worksurfaces may be used with Accelerate® and Voi® products.
- Worksurfaces are constructed of laminate on 1/8" solid core high-performance particleboard.
- One small worksurface bracket standard with each worksurface.
- ⓘ Corner worksurfaces must match exactly the panel behind them, i.e.: a 36" panel must be used on the back two sides of model HWCS3624P.

STRAIGHT COUNTERTOPS

Grain Direction

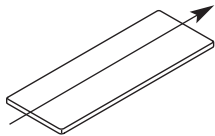

MODEL	DESCRIPTION	SHIP WEIGHT	CUBE	LIST PRICE
Accelerate® 15"D Straight Countertops				
HBCSR1536P.B9.LOFT	36"W x 15"D Silver Mesh laminate, Loft edge	27 Ⓢ	1.6	\$274
HBCSR1536P.PINC.PINC	36"W x 15"D Pinnacle laminate and edge	27 Ⓢ	1.6	\$274
HBCSR1536P.LFW1.FW	36"W x 15"D Florence Walnut laminate and edge	27 Ⓢ	1.6	\$274
HBCSR1536P.LDW1.DW	36"W x 15"D Designer White laminate and edge	27 Ⓢ	1.6	\$274
HBCSR1548P.B9.LOFT	48"W x 15"D Silver Mesh laminate, Loft edge	38 Ⓢ	2.1	\$298
HBCSR1548P.PINC.PINC	48"W x 15"D Pinnacle laminate and edge	38 Ⓢ	2.1	\$298
HBCSR1548P.LFW1.FW	48"W x 15"D Florence Walnut laminate and edge	38 Ⓢ	2.1	\$298
HBCSR1548P.LDW1.DW	48"W x 15"D Designer White laminate and edge	38 Ⓢ	2.1	\$298
HBCSR1560P.B9.LOFT	60"W x 15"D Silver Mesh laminate, Loft edge	48 Ⓢ	2.6	\$378
HBCSR1560P.PINC.PINC	60"W x 15"D Pinnacle laminate and edge	48 Ⓢ	2.6	\$378
HBCSR1560P.LFW1.FW	60"W x 15"D Florence Walnut laminate and edge	48 Ⓢ	2.6	\$378
HBCSR1560P.LDW1.DW	60"W x 15"D Designer White laminate and edge	48 Ⓢ	2.6	\$378
HBCSR1572P.B9.LOFT	72"W x 15"D Silver Mesh laminate, Loft edge	59 Ⓢ	3.1	\$406
HBCSR1572P.PINC.PINC	72"W x 15"D Pinnacle laminate and edge	59 Ⓢ	3.1	\$406
HBCSR1572P.LFW1.FW	72"W x 15"D Florence Walnut laminate and edge	59 Ⓢ	3.1	\$406
HBCSR1572P.LDW1.DW	72"W x 15"D Designer White laminate and edge	59 Ⓢ	3.1	\$406

NOTES:

- Countertops constructed with high-pressure laminate.



COUNTERTOP BRACKET KITS

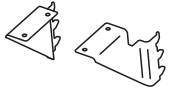

MODEL	DESCRIPTION	SHIP WEIGHT	CUBE	LIST PRICE
HECB01.LOFT	Accelerate® Countertop Bracket Kit Loft paint	1 Ⓞ	0.1	\$53
<p>❗ For use with all panel heights, except 42½".</p> <p>❗ Top caps required and specified separately from Accelerate® Countertop Bracket Kits.</p>				
HECB42.LOFT	Accelerate® Countertop Bracket Kit for 42½" H Panels Loft paint	1 Ⓞ	0.1	\$53
<p>❗ For use with 42½" H Panels only.</p> <p>❗ Top caps required and specified separately from Accelerate® Countertop Bracket Kits.</p> <p>❗ Bracket kits include one right and one left hand bracket. Order two sets of brackets for the straight countertop models and three sets for the corner countertop models. To be used on Accelerate® panels only.</p>				

WORKSURFACE SUPPORTS

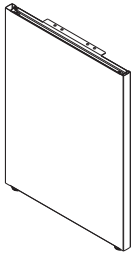

MODEL	DESCRIPTION	SHIP WEIGHT	CUBE	LIST PRICE
HRVEP2429R.LOFT	Accelerate® Full End Panel* 29½" H x 24" D — Right — Panel-Mount Loft paint	21 Ⓞ	1.4	\$223
HRVEP2429L.LOFT	29½" H x 24" D — Left — Panel-Mount Loft paint	21	1.4	\$223
HRVEP3029R.LOFT	29½" H x 30" D — Right — Panel-Mount Loft paint	23	1.4	\$242
HRVEP3029L.LOFT	29½" H x 30" D — Left — Panel-Mount Loft paint	23	1.4	\$242

NOTES: The use of an end panel at the end of a worksurface will increase the rigidity of the workstation. If the panel is a greater dimension than the worksurface, an end panel is required if the run of the worksurfaces is 8 feet or greater. Levelers provide 1½" vertical adjustment.

- ❗ *Must be connected into panel slots. When an installation of worksurfaces is 8 feet or greater, a full end panel or universal support leg must be used at 90 degree panel junctions or in a shared position to support adjoining worksurfaces.
- ❗ End panel support with bracket will attach to Accelerate® panels.

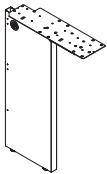

Non-handed unit

HRVCLG24.LOFT	Accelerate® Universal Support Leg* 29½" H to support 24" D, Loft paint	16 Ⓞ	1.4	\$197
HRVCLG30.LOFT	29½" H to support 30" D, Loft paint	17 Ⓞ	1.4	\$215

NOTES: Use at 90° panel junctions or in a shared position to support adjoining worksurfaces. Provided with flat bracket. Levelers provide 1½" vertical adjustment.

- ❗ *Must be connected into panel slots. When an installation of worksurfaces is 8 feet or greater, a full end panel or universal support leg must be used at 90 degree panel junctions or in a shared position to support adjoining worksurfaces.

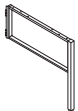

HOLEG24.LOFT	Open Leg Models* 29½" H x 24" D	11 Ⓞ	1.2	\$207
HOLEG30.LOFT	29½" H x 30" D	15 Ⓞ	1.8	\$225

NOTES: Loft paint. Open leg includes attaching hardware and leveling glides. Leveling glides provide 2¼" of adjustment. Open leg is universal shared with a left- and right-hand attachment bracket.

- ❗ *Must be connected into frame slots.

NOTES:

- The supports included on this page can be used with Systems and Worksurfaces.

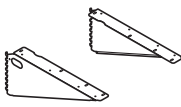
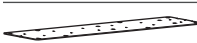
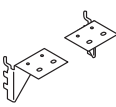

WORKSURFACE SUPPORTS

	MODEL	DESCRIPTION	SHIP WEIGHT	CUBE	LIST PRICE
	HCTL242.LOFT	Accessory Cantilever* 24"D Pair Loft paint	5 Ⓞ	0.3	\$83
	<p>⚠ *Must be connected into panel slots.</p> <p>⚠ Accelerate® only: Cantilevers only to be used on worksurface runs 72"W or less.</p> <p>⚠ Use with runs 72" or less – avoid installation on only one side of a straight connection except to support corner worksurfaces. Floor support is required for runs longer than 72".</p> <p>⚠ DO NOT position at the end of a panel run where no 90 degree return panel is positioned.</p> <p>⚠ DO NOT use to support worksurfaces from which a hanging pedestal is suspended, or to which a peninsula worksurface is attached.</p> <p>⚠ DO NOT use cantilever brackets to support worksurfaces supported with permanent wall hanger kit.</p>				
	HHN831124.S	Flat Bracket 24"D	3 Ⓞ	0.3	\$64
	HHN831130.S	30"D	3 Ⓞ	0.4	\$64
<p>NOTES: Charcoal finish. Flat Brackets can be used to connect one worksurface perpendicular to another worksurface.</p>					
	HWSB2.LOFT	Worksurface Bracket Kit* One Pair Loft paint	1 Ⓞ	0.1	\$47
	<p>NOTES: Used to connect the end of a worksurface to a panel of the same width.</p> <p>⚠ Always use when the depth side of a worksurface is against a panel (return/wing panel) of the same dimension. This will increase the sturdiness of the workstation.</p> <p>⚠ *Must be connected into panel slots.</p>				

NOTES:

- The supports included on this page can be used with Systems Worksurfaces.

WORKSURFACE BRACKETS

	MODEL	DESCRIPTION	SHIP WEIGHT	CUBE	LIST PRICE
	HPD2PNBRK2L.LOFT	Flagship* Pedestal to Panel Bracket Kit, Left Loft paint	3 Ⓞ	0.3	\$110
	HPD2PNBRK2R.LOFT	Flagship* Pedestal to Panel Bracket Kit, Right Loft paint	3 Ⓞ	0.3	\$110

NOTES:

- Bracket to attach 22⁷/₈"D pedestals to 24"D worksurface or 28⁷/₈"D pedestals to 30"D worksurface.

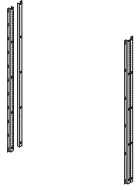

WORKSURFACE SUPPORTS

	MODEL	DESCRIPTION	SHIP WEIGHT	CUBE	LIST PRICE
	HRVC35PCE.LOFT	Accelerate® Permanent-Wall Hanger Kit Wall Hanger Kit (2 pieces) 2½"W x ¾"D x 66"H Loft paint	6 Ⓢ	0.7	\$220
<p>NOTES: Anchor devices are not supplied with these models. Refer to Accelerate® Installation instructions for appropriate hardware. Used to hang storage cabinets and bookshelves from permanent wall, and/or to attach worksurfaces to permanent wall.</p> <ul style="list-style-type: none"> ⓘ Attachment to masonry walls is not recommended. ⓘ Worksurfaces should not be supported with Cantilever brackets when using Permanent-Wall Hanger Kit. 					

NOTES:

- Wall track has ⅛" x ½" slots on 1" centers.
- Customer to furnish connecting hardware. (Refer to Installation Instructions for appropriate hardware.)
- Includes a cover for top of channel.

STANDARD HEIGHT SUPPORT PEDESTALS

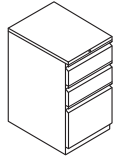
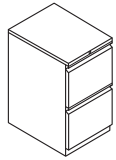
	MODEL	DESCRIPTION	SHIP WEIGHT	CUBE	LIST PRICE
	HVFB23R.L.LOFT	Standard Height Freestanding Support Pedestals — Box/Box/File 15"W x 22⅞"D x 28"H Lock, Loft paint	95	8.0	\$556
	HVFF23R.L.LOFT	Standard Height Freestanding Support Pedestals — File/File 15"W x 22⅞"D x 28"H Lock, Loft paint	94	8.0	\$551

NOTES:

- 28"H fits under all HON worksurfaces and desk shells.
- Ball-bearing suspension on file drawer (90% extension), and box drawer (90% extension on both drawers).
- File drawers have high sides for filing front-to-back.
- Available in "R" pull only.
- Pencil tray standard in top box drawer.
- One box divider standard in each box drawer.
- One crossrail standard in each file drawer.

ⓘ Freestanding models must be used under a worksurface only.

NOW

Empower® 60"W Typicals with 24"D Worksurfaces



Icon Legend on page 7

QTY	DESCRIPTION	MODEL	LIST PRICE	PRICE EXTENSION
2	Worksurface, Edgeband, No Grommets 24" x 60"	HWR2460PN	\$477	\$954
1	Double Depth U-Leg (Box of 2)	HMPEL4828	\$1,136	\$1,136
1	Support Beams (Box of 2) 60"W	HMPUB260	\$635	\$635
1	Shared Trough 60"W	HMPROUGH60	\$436	\$436
1	End of Run Electrical Kit 60"W	HMPEEK60*	\$225	\$225
1	Duplex 1	HH871501	\$42	\$42
1	Duplex 2	HH871502	\$42	\$42
1	Duplex 3	HH871503	\$42	\$42
1	Duplex 4	HH871504	\$42	\$42
TOTAL:			\$3,554	

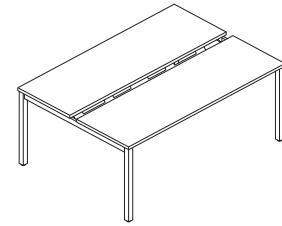

**2-PACK — 60"
60"W x 51"D**

QTY	DESCRIPTION	BUNDLE SKU	LIST PRICE
1	2-PACK BUNDLE Includes all Components Listed Above	HMP2460PK2	\$3,554

SPECIFYING EXAMPLE: Model.Laminate.Edgeband.Paint2.DuplexColor

NOTES: Typicals DO NOT include power in-feeds, screens, storage, or seating.

ADD FABRIC SCREENS — SEE PAGE 82 FOR PRICING

ADD 2 MOBILE PEDESTALS: \$1,138 — SEE PAGE 84

QTY	DESCRIPTION	MODEL	LIST PRICE	PRICE EXTENSION
4	Worksurface, Edgeband, No Grommets 24" x 60"	HWR2460PN	\$477	\$1,908
1	Double Depth U-Leg (Box of 2)	HMPEL4828	\$1,136	\$1,136
1	Double Depth Shared U-Leg (Singles)	HMPSL4828	\$468	\$468
2	Support Beams (Box of 2) 60"W	HMPUB260	\$635	\$1,270
2	Shared Trough 60"W	HMPROUGH60	\$436	\$872
1	Power Harness 60"W	HH871260	\$216	\$216
1	End of Run Electrical Kit 60"W	HMPEEK60*	\$225	\$225
2	Duplex 1	HH871501	\$42	\$84
2	Duplex 2	HH871502	\$42	\$84
2	Duplex 3	HH871503	\$42	\$84
2	Duplex 4	HH871504	\$42	\$84
TOTAL:			\$6,431	

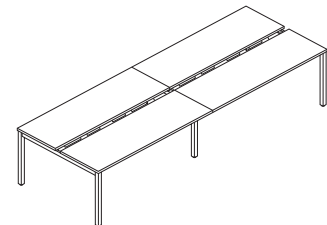

**4-PACK — 60"
144"W x 51"D**

QTY	DESCRIPTION	BUNDLE SKU	LIST PRICE
1	4-PACK BUNDLE Includes all Components Listed Above	HMP2460PK4	\$6,431

SPECIFYING EXAMPLE: Model.Laminate.Edgeband.Paint2.DuplexColor

NOTES: Typicals DO NOT include power in-feeds, screens, storage, or seating.

ADD FABRIC SCREENS — SEE PAGE 82 FOR PRICING ADD 4 MOBILE

PEDESTALS: \$2,276 — SEE PAGE 84

*HMPEEK60 End of Run Electrical Kit ships only in bundles.



Icon Legend on page 7

NOW

Empower® 60"W Typicals with 24"D Worksurfaces

QTY	DESCRIPTION	MODEL	LIST PRICE	PRICE EXTENSION
6	Worksurface, Edgeband, No Grommets 24" x 60"	HWR2460PN	\$477	\$2,862
1	Double Depth U-Leg (Box of 2)	HMPEL4828	\$1,136	\$1,136
2	Double Depth Shared U-Leg (Singles)	HMPSL4828	\$468	\$936
3	Support Beams (Box of 2) 60"W	HMPUB260	\$635	\$1,905
3	Shared Trough 60"W	HMPTROUGH60	\$436	\$1,308
2	Power Harness 60"W	HH871260	\$216	\$432
1	End of Run Electrical Kit 60"W	HMPEEK60*	\$225	\$225
3	Duplex 1	HH871501	\$42	\$126
3	Duplex 2	HH871502	\$42	\$126
3	Duplex 3	HH871503	\$42	\$126
3	Duplex 4	HH871504	\$42	\$126
TOTAL:				\$9,308

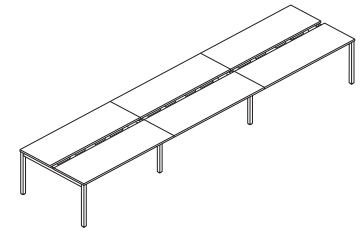

**6-PACK — 60"
180"W x 51"D**

QTY	DESCRIPTION	BUNDLE SKU	LIST PRICE
1	6-PACK BUNDLE Includes all Components Listed Above	HMP2460PK6	\$9,308

SPECIFYING EXAMPLE: Model.Laminate.Edgeband.Paint2.DuplexColor

NOTES: Typicals DO NOT include power in-feeds, screens, storage, or seating.

ADD FABRIC SCREENS — SEE PAGE 82 FOR PRICING

ADD 6 MOBILE PEDESTALS: \$3,414 — SEE PAGE 84

QTY	DESCRIPTION	MODEL	LIST PRICE	PRICE EXTENSION
8	Worksurface, Edgeband, No Grommets 24" x 60"	HWR2460PN	\$477	\$3,816
1	Double Depth U-Leg (Box of 2)	HMPEL4828	\$1,136	\$1,136
3	Double Depth Shared U-Leg (Singles)	HMPSL4828	\$468	\$1,404
4	Support Beams (Box of 2) 60"W	HMPUB260	\$635	\$2,540
4	Shared Trough 60"W	HMPTROUGH60	\$436	\$1,744
3	Power Harness 60"W	HH871260	\$216	\$648
1	End of Run Electrical Kit 60"W	HMPEEK60*	\$225	\$225
4	Duplex 1	HH871501	\$42	\$168
4	Duplex 2	HH871502	\$42	\$168
4	Duplex 3	HH871503	\$42	\$168
4	Duplex 4	HH871504	\$42	\$168
TOTAL:				\$12,185

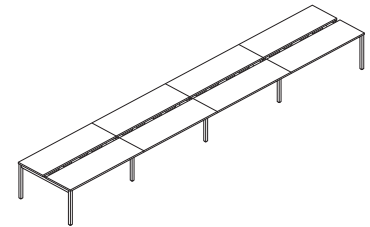

**8-PACK — 60"
240"W x 51"D**

QTY	DESCRIPTION	BUNDLE SKU	LIST PRICE
1	8-PACK BUNDLE Includes all Components Listed Above	HMP2460PK8	\$12,185

SPECIFYING EXAMPLE: Model.Laminate.Edgeband.Paint2.DuplexColor

NOTES: Typicals DO NOT include power in-feeds, screens, storage, or seating.

ADD FABRIC SCREENS — SEE PAGE 82 FOR PRICING

ADD 8 MOBILE PEDESTALS: \$4,552 — SEE PAGE 84

*HMPEEK60 End of Run Electrical Kit ships only in bundles.

NOW

Empower® 60"W Height Adjustable Typicals with 24"D Worksurfaces



Icon Legend on page 7

QTY	DESCRIPTION	MODEL	LIST PRICE	PRICE EXTENSION
2	Worksurface, Edgeband, No Grommets 24" x 60"	HHAW2460PN	\$499	\$998
1	Height Adjustable Base	HMPHA2S4C	\$2,286	\$2,286
1	Height Adjustable Shared Trough 60"W	HMPHATROUGH60	\$436	\$436
2	Single-Sided Trough Lid	HMPHASLID60	\$126	\$252
1	End of Run Electrical Kit 60"W	HMPEEK60*	\$225	\$225
1	Duplex 1	HH871501	\$42	\$42
1	Duplex 2	HH871502	\$42	\$42
1	Duplex 3	HH871503	\$42	\$42
1	Duplex 4	HH871504	\$42	\$42
TOTAL:				\$4,365

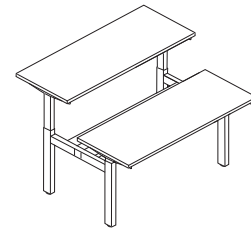

2-PACK — 60"
60"W x 51"D

QTY	DESCRIPTION	BUNDLE SKU	LIST PRICE
1	2-PACK BUNDLE Includes all Components Listed Above	HMPHA2460PK2	\$4,365

SPECIFYING EXAMPLE: Model.Laminate.Edgeband.BasePaint.TroughPaint.DuplexColor

NOTES: Typicals DO NOT include power in-feeds, screens, storage, or seating.

ADD FABRIC SCREENS — SEE PAGE 82 FOR PRICING

ADD 2 MOBILE PEDESTALS: \$1,138 — SEE PAGE 84

QTY	DESCRIPTION	MODEL	LIST PRICE	PRICE EXTENSION
4	Worksurface, Edgeband, No Grommets 24" x 60"	HHAW2460PN	\$499	\$1,996
2	Height Adjustable Base	HMPHA2S4C	\$2,286	\$4,572
2	Height Adjustable Shared Trough 60"W	HMPHATROUGH60	\$436	\$872
4	Single-Sided Trough Lid	HMPHASLID60	\$126	\$504
1	Power Harness 60"W	HH871260	\$216	\$216
1	End of Run Electrical Kit 60"W	HMPEEK60*	\$225	\$225
2	Duplex 1	HH871501	\$42	\$84
2	Duplex 2	HH871502	\$42	\$84
2	Duplex 3	HH871503	\$42	\$84
2	Duplex 4	HH871504	\$42	\$84
TOTAL:				\$8,721

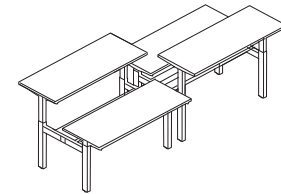

4-PACK — 60"
120"W x 51"D

QTY	DESCRIPTION	BUNDLE SKU	LIST PRICE
1	4-PACK BUNDLE Includes all Components Listed Above	HMPHA2460PK4	\$8,721

SPECIFYING EXAMPLE: Model.Laminate.Edgeband.BasePaint.TroughPaint.DuplexColor

NOTES: Typicals DO NOT include power in-feeds, screens, storage, or seating.

ADD FABRIC SCREENS — SEE PAGE 82 FOR PRICING

ADD 4 MOBILE PEDESTALS: \$2,276 — SEE PAGE 84

*HMPEEK60 End of Run Electrical Kit ships only in bundles.



Icon Legend on page 7

NOW

Empower® 60"W Height Adjustable Typical with 24"D Worksurfaces

QTY	DESCRIPTION	MODEL	LIST PRICE	PRICE EXTENSION
6	Worksurface, Edgeband, No Grommets 24" x 60"	HHAW2460PN	\$499	\$2,994
3	Height Adjustable Base	HMPHA2S4C	\$2,286	\$6,858
3	Height Adjustable Shared Trough 60"W	HMPHATROUGH60	\$436	\$1,308
6	Single-Sided Trough Lid	HMPHASLID60	\$126	\$756
2	Power Harness 60"W	HH871260	\$216	\$432
1	End of Run Electrical Kit 60"W	HMPEEK60*	\$225	\$225
3	Duplex 1	HH871501	\$42	\$126
3	Duplex 2	HH871502	\$42	\$126
3	Duplex 3	HH871503	\$42	\$126
3	Duplex 4	HH871504	\$42	\$126
TOTAL:				\$13,077

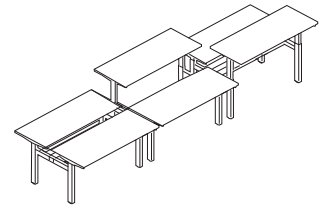

**6-PACK — 60"
180"W x 51"D**

QTY	DESCRIPTION	BUNDLE SKU	LIST PRICE
1	6-PACK BUNDLE Includes all Components Listed Above	HMPHA2460PK6	\$13,077

SPECIFYING EXAMPLE: Model.Laminate.Edgeband.BasePaint.TroughPaint.DuplexColor

NOTES: Typicals DO NOT include power in-feeds, screens, storage, or seating.

ADD FABRIC SCREENS — SEE PAGE 82 FOR PRICING

ADD 6 MOBILE PEDESTALS: \$3,414 — SEE PAGE 84

QTY	DESCRIPTION	MODEL	LIST PRICE	PRICE EXTENSION
8	Worksurface, Edgeband, No Grommets 24" x 60"	HHAW2460PN	\$499	\$3,992
4	Height Adjustable Base	HMPHA2S4C	\$2,286	\$9,144
4	Height Adjustable Shared Trough 60"W	HMPHATROUGH60	\$436	\$1,744
8	Single-Sided Trough Lid	HMPHASLID60	\$126	\$1,008
3	Power Harness 60"W	HH871260	\$216	\$648
1	End of Run Electrical Kit 60"W	HMPEEK60*	\$225	\$225
4	Duplex 1	HH871501	\$42	\$168
4	Duplex 2	HH871502	\$42	\$168
4	Duplex 3	HH871503	\$42	\$168
4	Duplex 4	HH871504	\$42	\$168
TOTAL:				\$17,433

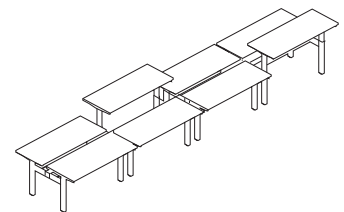

**8-PACK — 60"
240"W x 51"D**

QTY	DESCRIPTION	BUNDLE SKU	LIST PRICE
1	8-PACK BUNDLE Includes all Components Listed Above	HMPHA2460PK8	\$17,433

SPECIFYING EXAMPLE: Model.Laminate.Edgeband.BasePaint.TroughPaint.DuplexColor

NOTES: Typicals DO NOT include power in-feeds, screens, storage, or seating.

ADD FABRIC SCREENS — SEE PAGE 82 FOR PRICING

ADD 8 MOBILE PEDESTALS: \$4,552 — SEE PAGE 84

*HMPEEK60 End of Run Electrical Kit ships only in bundles.

NOW Empower® Workstations

GSA SIN 33721 EXCEPT AS NOTED



Icon Legend on page 7

LEGS FOR LINEAR APPLICATIONS

	MODEL	DESCRIPTION	SHIP WEIGHT	CUBE	LIST PRICE
	HMPPEL4828.PJW	Double Depth U-Leg (Box of 2) 50½"D for use with 24"D Worksurfaces Designer White paint NOTES: Ships as a box of 2 legs.	32.4	14.9	\$1136
	HMPPSL4828.PJW	Double Depth Shared U-Leg (Singles) 30"D for use with 24"D Worksurfaces Designer White paint	21.1	4.9	\$468

SUPPORT BEAMS

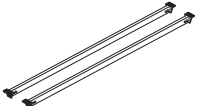
	MODEL	DESCRIPTION	SHIP WEIGHT	CUBE	LIST PRICE
	HMPUB260	Support Beams (Box of 2) 60"W Graphite finish	15.8	0.7	\$635

NOTES:

- For use with double-sided stations. One support beam per worksurface is needed.
- For use with single-sided stations. 48"W returns will use the 60"W Support Beam.

- ! Available in graphite finish only. No specification needed.
- ! Support Beams used with Empower® linear applications only.

HEIGHT ADJUSTABLE BASES

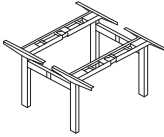
	MODEL	DESCRIPTION	SHIP WEIGHT	CUBE	LIST PRICE
	HMPHA2S4C	Height Adjustable Base Back-to-Back Workstation	130	5.3	\$2286

OPEN MARKET



SYSTEMS WORKSURFACES

	MODEL	DESCRIPTION	SHIP WEIGHT	CUBE	LIST PRICE
Grain Direction 	HWR2460PN.LDW1.DW	24"D Worksurface with Edgeband 60"W x 24"D Designer White laminate, Designer White edge	70	4.0	\$477
	HWR2460PN.LFW1.FW	60"W x 24"D Florence Walnut laminate, Florence Walnut edge	70	4.0	\$477
	HWR2460PN.PINC.PINC	60"W x 24"D Pinnacle laminate, Pinnacle edge	70	4.0	\$477
NOTES: For use as a primary surface.					
Grain Direction 	HHAW2460PN.LDW1.DW	24"D Height Adjustable Worksurfaces 60"W x 24"D Designer White laminate, Designer White edge	70	3.9	\$499
	HHAW2460PN.LFW1.FW	60"W x 24"D Florence Walnut laminate, Florence Walnut edge	70	3.9	\$499
	HHAW2460PN.PINC.PINC	60"W x 24"D Pinnacle laminate, Pinnacle edge	70	3.9	\$499

NOTES:

- Worksurfaces are constructed of laminate on 1/8" solid core high-performance particleboard.
- ! All worksurfaces load tested to BIFMA standards.
- ! Stack-on storage cannot be used on Empower® benching.

NOW Empower® Workstations

GSA SIN AS NOTED

Icon Legend on page 7

WIRE TROUGHS

	MODEL	DESCRIPTION	SHIP WEIGHT	CUBE	LIST PRICE
   SIN 33721	HMPTROUGH60	Trough — Double-Sided 60"W Graphite finish	4.3	6.8	\$436

NOTES:

- Slots available in trough to zip tie data cables to the trough.
- Double-sided wire trough rests on top of support bars. No fasteners needed.
- ! Available in graphite finish only. No specification needed.
- ! HMPTROUGH60 used with Empower® linear applications only.

WIRE TROUGHS FOR HEIGHT ADJUSTABLE BASES

	MODEL	DESCRIPTION	SHIP WEIGHT	CUBE	LIST PRICE
 OPEN MARKET	HMPHATROUGH60.PJW	Trough for Height Adjustable Base — Double-Sided 60"W Designer White paint	6.5	2.2	\$436
 OPEN MARKET	HMPHASLID60.PJW	Trough Lid — Single-Sided For 60"W Trough Designer White paint	4.0	0.5	\$126

NOTES:

- Slots available in trough to zip tie data cables to the trough.
- Trough attaches to crossbeam connected to the height adjustable columns.
- 2 trough lids needed per double-sided trough.



SIDE SCREENS

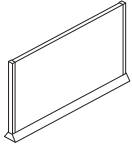

MODEL	DESCRIPTION	SHIP WEIGHT	CUBE	LIST PRICE
HMPDFS2413.PJW.APN24	Fabric Side Screen 24"D x 13"H Designer White paint, Appoint Platinum fabric	4.5	2.1	\$418
HMPDFS2413.PJW.APN27	24"D x 13"H Designer White paint, Appoint Jet fabric	4.5	2.1	\$418
HMPDFS2413.PJW.APN28	24"D x 13"H Designer White paint, Appoint Carbon fabric	4.5	2.1	\$418

NOTES

- Fabric screen adheres to the top of the worksurface with heavy-duty double stick tape.



CENTER SCREENS FABRIC

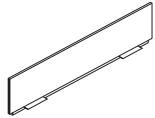

MODEL	DESCRIPTION	SHIP WEIGHT	CUBE	LIST PRICE
	Fabric Screens (Shared) — 13”H			
HMPCF54813.PJW.APN24	48”W Designer White paint, Appoint Platinum fabric	10.3	1.8	\$596
HMPCF54813.PJW.APN27	48”W Designer White paint, Appoint Jet fabric	10.3	1.8	\$596
HMPCF54813.PJW.APN28	48”W Designer White paint, Appoint Carbon fabric	10.3	1.8	\$596
HMPCF56013.PJW.APN24	60”W Designer White paint, Appoint Platinum fabric	12.3	2.3	\$683
HMPCF56013.PJW.APN27	60”W Designer White paint, Appoint Jet fabric	12.3	2.3	\$683
HMPCF56013.PJW.APN28	60”W Designer White paint, Appoint Carbon fabric	12.3	2.3	\$683

! Not for use with height adjustable base.

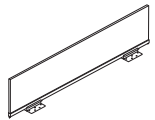

	Fabric Screens (Single) — 13”H			
HMPFSS4813.PJW.APN24	48”W Designer White paint, Appoint Platinum fabric	12.3	2.9	\$591
HMPFSS4813.PJW.APN27	48”W Designer White paint, Appoint Jet fabric	12.3	2.9	\$591
HMPFSS4813.PJW.APN28	48”W Designer White paint, Appoint Carbon fabric	12.3	2.9	\$591
HMPFSS5413.PJW.APN24	54”W Designer White paint, Appoint Platinum fabric	13.6	2.4	\$620
HMPFSS5413.PJW.APN27	54”W Designer White paint, Appoint Jet fabric	13.6	2.4	\$620
HMPFSS5413.PJW.APN28	54”W Designer White paint, Appoint Carbon fabric	13.6	2.4	\$620
HMPFSS6013.PJW.APN24	60”W Designer White paint, Appoint Platinum fabric	14.8	3.6	\$678
HMPFSS6013.PJW.APN27	60”W Designer White paint, Appoint Jet fabric	14.8	3.6	\$678
HMPFSS6013.PJW.APN28	60”W Designer White paint, Appoint Carbon fabric	14.8	3.6	\$678

OPEN MARKET

NOTES:

- ! Only single-sided screens can be specified with height adjustable workstations.
- ! When using a power pole, the screen on the station with the pole must be 6” shorter to allow space for the pole to be mounted.

Fabric Screen Specifying Guide

Static Rectangle Worksurface Width	Inset 6” on Each Side	Full Length
60”	48”	60”

Height Adjustable Rectangle Worksurface Width	Inset 5” on Each Side	Inset 2” on Each Side
60” (undersized)	48”	54”



Icon Legend on page 7

NOW Empower® Workstations

ELECTRICAL AND DATA

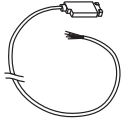

MODEL	DESCRIPTION	SHIP WEIGHT	CUBE	LIST PRICE
HMP144	Power In-Feed — Sealtight 144" long conduit, Sealtight Cable — 7/8" diameter	7	1.2	\$333

NOTES: For use as ceiling, floor and wall in-feed. If three-circuit, separate neutral in-feed is required, please contact Tailored Solutions.

ELECTRICAL ACCESSORIES



MODEL	DESCRIPTION	SHIP WEIGHT	CUBE	LIST PRICE
HMPPP125.PJW	Empower® Power Pole 10'5"	14.0	0.7	\$464

NOTES: Power pole ships with bracket to attach under Empower worksurfaces and feed directly into the Wire Management trough.

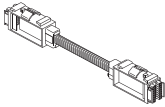

HMPEEK60	End of Run Electrical Kit 60"W	3.0	0.5	\$225
-----------------	------------------------------------------	-----	-----	--------------



HMPVWM28.X	Vertebrae Clear finish	3.0	0.3	\$223
-------------------	----------------------------------	-----	-----	--------------

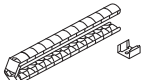

OPEN MARKET

HMPHAWTWML.X	Wire Managers for Height Adjustable Workstation to Trough Black finish	3.0	0.1	\$267
---------------------	-------------------------------------------------------------------------------------	-----	-----	--------------

ⓘ Wire Manager Workstation to Trough only available in black.

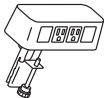

HCOMDOME2.LOFT	Power & Data Center 2 Receptacles 2 Data Accessory	2.5 ⓘ	0.2	\$296
-----------------------	------------------------------------------------------------------	-------	-----	--------------

- Standard with two receptacles and openings for two data ports.
- 6' power cord with standard three-prong plug.
- Fits on any worksurface with a 4" overhang.
- UL Listed.

NOW Empower® Workstations

GSA SIN 33721 EXCEPT AS NOTED



MOBILE PEDESTALS

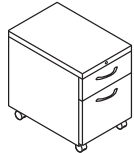

MODEL	DESCRIPTION	SHIP WEIGHT	CUBE	LIST PRICE
H15923A.L.PJW <i>For Empower® Workstations</i>	Mobile Pedestals — Box/File 15"W x 22 ⁷ / ₈ "D x 22"H Satin Chrome Arch pull, Lock, Designer White paint	92	6.0	\$569

NOTES: Pencil tray standard in top box drawer. One box divider standard in each box drawer. One crossrail standard in each file drawer. File drawers have high sides for filing front-to-back. Steel ball-bearing suspension on file drawer, and box drawer. Equipped with HON "One Key" interchangeable core removable locks. Counterweight standard.

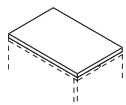

MODEL	DESCRIPTION	SHIP WEIGHT	CUBE	LIST PRICE
HPSEAT24ND.PNS007	Pedestal Seat 15"W x 22 ⁷ / ₈ "D x 2"H Appoint Jet fabric	10	1.2	\$224
HPSEAT24ND.PNS008	15"W x 22 ⁷ / ₈ "D x 2"H Appoint Carbon fabric	10	1.2	\$224
HPSEAT24ND.PNS004	15"W x 22 ⁷ / ₈ "D x 2"H Appoint Platinum fabric	10	1.2	\$224

OPEN MARKET

LAMINATE MOBILE STORAGE

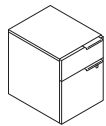

MODEL	DESCRIPTION	SHIP WEIGHT	CUBE	LIST PRICE
HLSL2016MP2.LDW1.LDW1.PR6	Mobile Pedestal 15 ³ / ₄ "W x 20 ¹ / ₁₆ "D x 21 ⁷ / ₁₆ "H Designer White chassis, Designer White drawer fronts, Silver pulls	65	5.7	\$794
HLSL2016MP2.LFW1.LFW1.PR6	15 ³ / ₄ "W x 20 ¹ / ₁₆ "D x 21 ⁷ / ₁₆ "H Florence Walnut chassis, Florence Walnut drawer fronts, Silver pulls	65	5.7	\$794
HLSL2016MP2.PINC.PINC.PR6	15 ³ / ₄ "W x 20 ¹ / ₁₆ "D x 21 ⁷ / ₁₆ "H Pinnacle chassis, Pinnacle drawer fronts, Silver pulls	65	5.7	\$794

NOTES: Unit is locking.

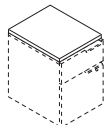

MODEL	DESCRIPTION	SHIP WEIGHT	CUBE	LIST PRICE
HLSL2016PH2.PNS004	Mobile Pedestal Cushion 15 ⁷ / ₈ "W x 20"D x 1"H for Pedestals Appoint Platinum fabric	6	1.1	\$333
HLSL2016PH2.PNS007	15 ⁷ / ₈ "W x 20"D x 1"H for Pedestals Appoint Jet fabric	6	1.1	\$333
HLSL2016PH2.PNS008	15 ⁷ / ₈ "W x 20"D x 1"H for Pedestals Appoint Carbon fabric	6	1.1	\$333

NOTES:

- File drawers accept hanging folders in letter or legal size.
- Multiple handle locations possible per customer preference.
- Standard box drawers operate on ball-bearing suspension with 70% extension. File drawers operate on ball-bearing suspension with 70% extension.
- Ships with one handle per drawer on all units.

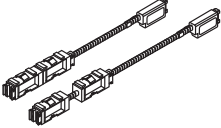

ELECTRICAL COMPONENTS

	MODEL		DESCRIPTION	MAX. RECEPT. CAP. PER PANEL SIDE	SHIP WEIGHT	CUBE	LIST PRICE
	FOUR-CIRCUIT						
	3 + 1	2 + 2					
	HH871224		Electrical Power Harnesses, Frames — w/duplex capacity For 24"W	1	2.0 Ⓞ	0.5	\$206
	HH871230		For 30"W	2	2.0 Ⓞ	0.5	\$206
	HH871236		For 36"W	2	2.5 Ⓞ	0.5	\$206
	HH871248		For 48"W	2	3.0 Ⓞ	0.5	\$216
	HH871260		For 60"W	2	3.0 Ⓞ	0.5	\$216

NOTES: Electric harnesses are intended for use with HON Systems furniture and are approved under GSA SIN 33721. When purchased separately and used without HON Systems furniture, the models are considered Open Market.

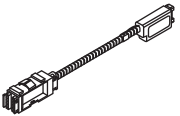
	MODEL		DESCRIPTION	MAX. RECEPT. CAP. PER PANEL SIDE	SHIP WEIGHT	CUBE	LIST PRICE
	FOUR-CIRCUIT						
	3 + 1	2 + 2					
	HH871124		Electrical Pass-Thru Cables, Frames — w/duplex capacity For 24"W	1	2.0 Ⓞ	0.5	\$129
	HH871130		For 30"W	1	2.0 Ⓞ	0.5	\$129
	HH871136		For 36"W	1	2.0 Ⓞ	0.5	\$129
	HH871148		For 48"W	1	2.5 Ⓞ	0.5	\$136
	HH871160		For 60"W	1	3.0 Ⓞ	0.5	\$136

NOTES: For use when data will be terminated in one cutout in the panel. Electric harnesses are intended for use with HON Systems furniture and are approved under GSA SIN 33721. When purchased separately and used without HON Systems furniture, the models are considered Open Market.

MODEL	DESCRIPTION	SHIP WEIGHT	CUBE	LIST PRICE
HH879072	Power In-Feed Cables — Base In-Feed 72" long conduit, Sealtight Cable — 7/8" diameter	4.5 Ⓞ	0.3	\$229

ⓘ To connect power between the base pathway and the beltline area on Abound, four-circuit jumper cables (H8713xx) must be connected to a power block at one end of a run, routed into an adjacent panel that contains no power harness, then routed back into the panel that contains a power harness (or pass-thru cable), and connected to a power harness in the other pathway.

MODEL	DESCRIPTION	SHIP WEIGHT	CUBE	LIST PRICE
HH871912	Ceiling In-Feed 144" long conduit, Flex Cable — 7/8" dia.	4.0 Ⓞ	0.5	\$238

ⓘ Must be used with Power Pole. Power in-feed model HH871912 plugs into the end of any power block. No portion of the cable can be exposed after installation.

ⓘ To connect power between the base pathway and the beltline area on Abound, four-circuit jumper cables (H8713xx) must be connected to a power block at one end of a run, routed into an adjacent panel that contains no power harness, then routed back into the panel that contains a power harness (or pass-thru cable), and connected to a power harness in the other pathway.

MODEL	DESCRIPTION	SHIP WEIGHT	CUBE	LIST PRICE
HH871400	Hardwire Applications Hardwire Power In-feed	4.0 Ⓞ	0.3	\$224
HH871500	Hardwire Junction Box (6-pack)	4.5 Ⓞ	0.1	\$477

ⓘ Customer to furnish all cabling and wiring from power entry to power source (approved for use by city of New York).

ⓘ For use with Accelerate® Beltline only.

NOTES: Junction Box can be positioned at any Duplex Receptacle location in 30"W or wider panels.

ⓘ Customer must furnish conduit, wiring and designer type receptacles. (Approved for use by city of Chicago.)

ⓘ To connect power between the base pathway and the beltline area on Abound, four-circuit jumper cables (H8713xx) must be connected to a power block at one end of a run, routed into an adjacent panel that contains no power harness, then routed back into the panel that contains a power harness (or pass-thru cable), and connected to a power harness in the other pathway.





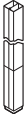

Use when local codes require

ELECTRICAL COMPONENTS

	MODEL	DESCRIPTION	SHIP WEIGHT	CUBE	LIST PRICE
	HH870070.PJW	Power Pole — w/o Receptacles (Voi® only) 10'5" Designer White paint	140	0.5	\$433

- Used for routing In-Feed Cable from ceiling to panel baserail. Double cavity, plus conduit of In-Feed Cable serves as the division of electrical and communications cabling.





	HECPP.LOFT	Accelerate® Integrated Power Pole 78"H x 2"W x 2"D Loft paint	14 	0.5	\$276
-----------------------------------------------------------------------------------	-------------------	----------------------------------------------------------------------------	--------------------------------------------------------------------------------------	-----	--------------

	HHTADF3	AMP Data Faceplates Three-port flex-mode faceplate	1.0 	0.2	\$26
	HHTADF4.P	Four-port flex-mode faceplate	1.0 	0.2	\$26
	HHTADF4	AMP RJ45 CAT 5E Jack — Black (P)	1.0 	0.1	\$42
	HHTADJ5	AMP RJ45 CAT 6 Jack — Black (P)	1.0 	0.1	\$57

*HHTADJ5
Black only*

Models HHTADJ5 and HHTADJ6 snap into faceplate.

NOTES: AMP Data Faceplates attach to bottom of panel or at worksurface height in front of baserail covers for easy cable routing. Faceplates cannot be installed back-to-back in a panel application.

	MODEL	DESCRIPTION	SHIP WEIGHT	CUBE	LIST PRICE
	FOUR-CIRCUIT				
	3+1				
	2+2				
	HH871501.LOFT	Accelerate® and Empower® Duplex Receptacles Circuit 1 Loft paint	1 	0.5	\$42
	HH871502.LOFT	Circuit 2 Loft paint	1 	0.5	\$42
	HH871503.LOFT	Circuit 3 (except 2 + 2 — see below) Loft paint	1 	0.5	\$42
	HH871504.LOFT	Circuit 4 — isolated, dedicated circuit Loft paint	1 	0.5	\$42



*Each marked with
Circuit Number*

NOTES: Data/Electrical Port Kit used for field installations of additional data accessories.





Maximum Receptacle Capacity in Accelerate® Panel Base Raceways

Widths	24	30	36	42	48	60
Maximum of 1 duplex per panel side		X				
Maximum of 2 duplexes per panel side			X	X	X	X

ACCESSORIES — ELECTRICAL

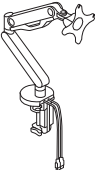
	MODEL	DESCRIPTION	SHIP WEIGHT	CUBE	LIST PRICE
	HPWRMOD2WC.SNW	Power Modules 2 Receptacles 2 USB with Worksurface Clamp Snow finish	2.3 	0.2	\$496
		<ul style="list-style-type: none"> • 6' power cord with standard three-prong plug. • Worksurface clamp models work on any top with a 4" overhang. • UL Listed. 			

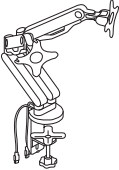
ACCESSORIES — MONITOR ARMS

	MODEL	DESCRIPTION	SHIP WEIGHT	CUBE	LIST PRICE
	HBSMAUSB	Single Monitor Arm with 2 USB Ports	38.6	2.4	\$255
					
	HBDMAUSB	Dual Monitor Arm with 2 USB Ports	41.9	2.6	\$441
		NOTES: Easy adjustment. Height adjusts to 17" tall. Monitor tilt and swivel capability. Enclosed cable management. Grommet or desktop mounting. Clean appearance. In some applications the Monitor Arms may extend 12 or more inches into the worksurface. HON 5-Year Limited Warranty.  No specification needed.			
OPEN MARKET					

NOTES:

Monitor Arms

- For use on 17"-30" monitors; up to 17.6 lbs.
- Built-in dual USB 3 ports.
- Height adjusts to 17" tall.
- Monitor tilt and swivel capability.
- Ships with hardware for grommet or clamp attachment to worksurface.
- Arms feature double extension, allowing 20"+ of back and forth movement.
- Cable management on both pole and arm assemblies.
- **HON 5-Year Limited Warranty.**

 Cannot be used in Empower® height adjustable applications.

NOTES

NOW Storage Fabrics and Finishes

PAINT



Black
P
*Brigade®
310 Series
510 Series*

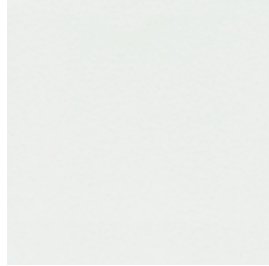

Designer White
PJW
*Flagship®
Fuse™*



Light Gray
Q
*Brigade®
310 Series*

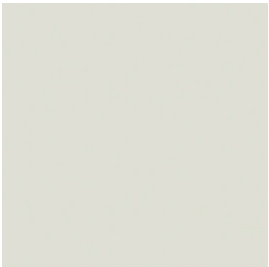

Loft
LOFT
*Brigade®
Flagship®*

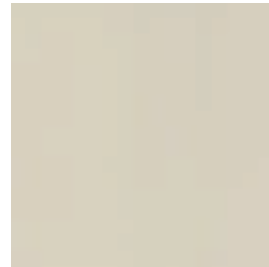

Putty
L
*Brigade®
310 Series
510 Series*

CUSHION FABRICS



Appoint Platinum
PNS004
Pedestal Seat

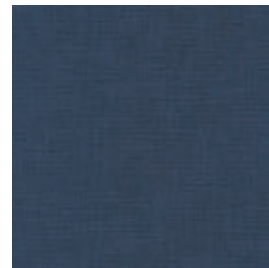

Appoint Jet
PNS007
Pedestal Seat

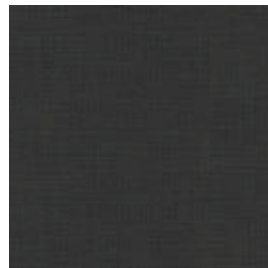

Appoint Carbon
PNS008
Pedestal Seat

STANDARD HEIGHT PEDESTALS

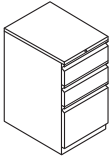
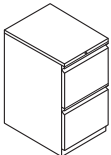
	MODEL	DESCRIPTION	SHIP WEIGHT	CUBE	LIST PRICE
	H33723R.L.LOFT	Standard Height Mobile Pedestals — Box/Box/File 15"W x 22 ⁷ / ₈ "D x 28"H Full Radius pull, Lock, Loft paint	77	7.5	\$630
	H33723R.L.P	15"W x 22 ⁷ / ₈ "D x 28"H Full Radius pull, Lock, Black paint	77	7.5	\$630
	H33723R.L.Q	15"W x 22 ⁷ / ₈ "D x 28"H Full Radius pull, Lock, Light Gray paint	77	7.5	\$630
	H33823R.L.L	Standard Height Mobile Pedestals — File/File 15"W x 22 ⁷ / ₈ "D x 28"H Full Radius pull, Lock, Putty paint	77	7.5	\$624
	H33823R.L.LOFT	15"W x 22 ⁷ / ₈ "D x 28"H Full Radius pull, Lock, Loft paint	77	7.5	\$624
	H33823R.L.P	15"W x 22 ⁷ / ₈ "D x 28"H Full Radius pull, Lock, Black paint	77	7.5	\$624

NOTES:

- 28"H fits under all HON worksurfaces and desk shells.
- Pencil tray standard in top box drawer.
- One box divider standard in each box drawer.
- One crossrail standard in each file drawer.
- Ball-bearing suspension on file and box drawers with 90% extension.
- File drawers have high sides for filing front-to-back.
- Equipped with HON "One Key" interchangeable core removable locks.
- Front casters are fixed, rear casters swivel on mobile pedestals.
- "R" pull matches Brigade 800 Series Lateral Pull.



NOW Brigade® 800 Series Storage

LATERAL FILES W/DRAWERS



MODEL	DESCRIPTION	SHIP WEIGHT	CUBE	LIST PRICE
H872.L.LOFT	Lateral File — 2 Drawer 30"W x 18"D x 28"H Lock, Loft paint	121	12.2	\$807
H882.L.LOFT	36"W x 18"D x 28"H Lock, Loft paint	131	14.3	\$902

NOTES:

- 30" & 36" case widths with drawers, 18" case depth.
- Flush top and sides.
- Reinforced case construction.
- Four adjustable leveling glides.
- Full-width radius designer style pull.
- Features drawer extension restraint; mechanical interlock inhibits the extension of more than one drawer at a time.
- Three-part, telescoping, steel ball-bearing suspension.
- Two adjustable hangrails per drawer for side-to-side filing.
- Counterweight included where applicable to meet ANSI/BIFMA stability requirements.
- Lock mechanism secures both sides of drawer.
- Baked enamel finish over rust-inhibiting phosphate pre-treatment.
- Equipped with HON "One Key" interchangeable core removable locks.



NOW Brigade® 600 Series Storage

GSA SIN 33721



Icon Legend on page 7

LATERAL FILES W/DRAWERS

	MODEL	DESCRIPTION	SHIP WEIGHT	CUBE	LIST PRICE
	H682.L.L	Lateral File — 2 Drawer 36"W x 18"D x 28"H Lock, Putty paint	131	14.3	\$801
	H682.L.P	36"W x 18"D x 28"H Lock, Black paint	131	14.3	\$801
	H682.L.Q	36"W x 18"D x 28"H Lock, Light Gray paint	131	14.3	\$801
	H683.L.L	Lateral File — 3 Drawer 36"W x 18"D x 39 ¹ / ₈ "H Lock, Putty paint	175	19.1	\$1119
	H683.L.P	36"W x 18"D x 39 ¹ / ₈ "H Lock, Black paint	175	19.1	\$1119
	H683.L.Q	36"W x 18"D x 39 ¹ / ₈ "H Lock, Light Gray paint	175	19.1	\$1119
	H684.L.L	Lateral File — 4 Drawer 36"W x 18"D x 52 ¹ / ₂ "H Lock, Putty paint	217	25.1	\$1389
	H684.L.P	36"W x 18"D x 52 ¹ / ₂ "H Lock, Black paint	217	25.1	\$1389
	H684.L.Q	36"W x 18"D x 52 ¹ / ₂ "H Lock, Light Gray paint	217	25.1	\$1389

NOTES:

- 36" case widths with drawers, 18" case depth.
- Flush top and sides.
- Reinforced case construction.
- Four adjustable leveling glides.
- Features drawer extension restraint; mechanical interlock inhibits the extension of more than one drawer at a time.
- Three-part, telescoping, steel ball-bearing suspension.
- Two adjustable hangrails per drawer/roll-out shelf for side-to-side filing.
- Counterweight included where applicable to meet ANSI/BIFMA stability requirements.
- Lock mechanism secures both sides of drawer.
- Baked enamel finish over rust-inhibiting phosphate pre-treatment.
- Bright anodized aluminum recessed drawer pull.
- Equipped with HON "One Key" interchangeable core removable locks.



MOBILE PEDESTALS

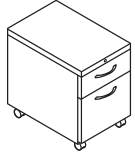

SIN 33721

MODEL	DESCRIPTION	SHIP WEIGHT	CUBE	LIST PRICE
H15923A.L.PJW <i>For Empower® Workstations</i>	Mobile Pedestals — Box/File 15"W x 22 ⁷ / ₈ "D x 22"H Satin Chrome Arch pull, Lock, Designer White paint	92	6.0	\$585
H15923A.L.LOFT <i>For Accelerate® Workstations</i>	15"W x 22 ⁷ / ₈ "D x 22"H Satin Chrome Arch pull, Lock, Loft paint	92	6.0	\$585

NOTES: Pencil tray standard in top box drawer. One box divider standard in each box drawer. One crossrail standard in each file drawer. File drawers have high sides for filing front-to-back. Steel ball-bearing suspension on file drawer, and box drawer. Equipped with HON "One Key" interchangeable core removable locks. Counterweight standard. Omit lock-option available.

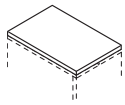

OPEN MARKET

MODEL	DESCRIPTION	SHIP WEIGHT	CUBE	LIST PRICE
HPSEAT24ND.PNS007	Pedestal Seat 15"W x 22 ⁷ / ₈ "D x 2"H Appoint Jet fabric	10	1.2	\$224
HPSEAT24ND.PNS008	15"W x 22 ⁷ / ₈ "D x 2"H Appoint Carbon fabric	10	1.2	\$224
HPSEAT24ND.PNS004	15"W x 22 ⁷ / ₈ "D x 2"H Appoint Platinum fabric	10	1.2	\$224



MOBILE PEDESTALS

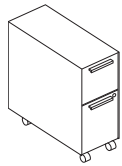

MODEL	DESCRIPTION	SHIP WEIGHT	CUBE	LIST PRICE
HAPMBS239TFN.SPR6.PJW.PJW.DW.L	Slim Mobile Pedestal, 9" Bin with Tray/12" File Square Silver pull, Designer White paint and Tray, Standard lock	47	4.9	\$710

NOTES:

- Designed to make the most of the compressed footprint of desking, benching, and height adjustable workstations.
- Extra thick, low-profile case provides increased strength and durability while providing a modern 360-degree aesthetic.
- Casters are designed to clear the top of Coordinate feet.
- Includes accessory tray to organize pens, notepads, sticky notes, etc.

UNDERMOUNT STORAGE

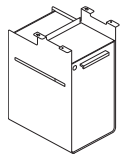

MODEL	DESCRIPTION	SHIP WEIGHT	CUBE	LIST PRICE
HAUFHR15N.SPR6.PJW.PJW.L	Undermount Storage with Locking Door Square Silver pull, Designer White paint, Right-Hinged, Standard lock	24	3.3	\$442

NOTES:

- Compatible with all HON benching, desking, and height adjustable tables, except where required space is unavailable.
- Ensure weight limit of height adjustable table system is considered before adding undermount storage.
- Contains a side slot on each side which can be used to hang Workplace Tools.
- 42 lb. storage capacity based on BIFMA loading standards.

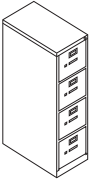
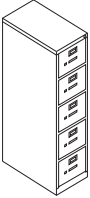

VERTICAL FILES

	MODEL	DESCRIPTION	SHIP WEIGHT	CUBE	LIST PRICE
		Vertical File — 2 Drawer			
	H312.P.L	15"W x 26½"D x 29"H, Letter Lock, Putty paint	60	9.2	\$493
	H312.P.P	15"W x 26½"D x 29"H, Letter Lock, Black paint	60	9.2	\$493
	H312.P.Q	15"W x 26½"D x 29"H, Letter Lock, Light Gray paint	60	9.2	\$493
		Vertical File — 4 Drawer			
	H314.P.L	15"W x 26½"D x 52"H, Letter Lock, Putty paint	107	16.03	\$670
	H314.P.P	15"W x 26½"D x 52"H, Letter Lock, Black paint	107	16.03	\$670
	H314.P.Q	15"W x 26½"D x 52"H, Letter Lock, Light Gray paint	107	16.03	\$670
		Vertical File — 5 Drawer			
	H315.P.L	15"W x 26½"D x 60"H, Letter Lock, Putty paint	128	20.94	\$982
	H315.P.P	15"W x 26½"D x 60"H, Letter Lock, Black paint	128	20.94	\$982
	H315.P.Q	15"W x 26½"D x 60"H, Letter Lock, Light Gray paint	128	20.94	\$982

NOTES:

- 26½" Case depth with 25 front-to-back filing inches per drawer.
- Three-part, telescoping, steel ball-bearing suspension.
- Bright aluminum drawer pulls, label holders and thumb latch.
- Standard interchangeable core removable locks. Equipped with HON "One Key" system.
- Accepts hanging files. High drawer sides hold hanging file folders without use of hangrails.
- Spring loaded follower block with positive side-action positioning is adjustable on ½" centers.
- Baked enamel finish over rust-inhibiting phosphate pre-treatment.

NOW 510 Series Storage

GSA SIN 33721

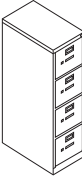

VERTICAL FILES

	MODEL	DESCRIPTION	SHIP WEIGHT	CUBE	LIST PRICE
	H512.P.L	Vertical File — 2 Drawer 15"W x 25"D x 29"H, Letter Lock, Putty paint	58	8.12	\$430
	H512.P.P	15"W x 25"D x 29"H, Letter Lock, Black paint	58	8.12	\$430
	H514.P.L	Vertical File — 4 Drawer 15"W x 25"D x 52"H, Letter Lock, Putty paint	102	17.42	\$580
	H514.P.P	15"W x 25"D x 52"H, Letter Lock, Black paint	102	17.42	\$580

NOTES:

- 25" Case depth with 23½" front-to-back filing inches per drawer.
- Three-part telescoping, ball-bearing steel suspension.
- Bright aluminum drawer pulls, label holders and thumb latch.
- Standard interchangeable core removable locks. Equipped with HON "One Key" system.
- Accepts hanging files. High drawer sides hold hanging file folders without use of hangrails.
- Adjustable wire follower.
- Baked enamel finish over rust-inhibiting phosphate pre-treatment.



Lateral File Accessories Storage

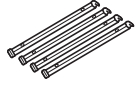

MODEL

DESCRIPTION

SHIP WEIGHT

CUBE

LIST PRICE

H919491

Single Rail Hanging File Racks (4/pack)
Gray finish

1.0 **Ⓢ**

0.4

\$67

NOTES: For front-to-back filing — 30"W, 36"W and 42"W files. Order one package per drawer for 42"W files. One package will do two 30"W or 36"W file drawers. Racks span between 15 1/4"W rails. Hanging file racks and dividers available in Gray only.

! Gray only.

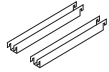

H919492

Double-Rail Hanging File Racks (2/pack)
Gray finish

1.5 **Ⓢ**

0.4

\$67

NOTES: For 3 rows front-to-back — 42"W files. Order one package per drawer. Racks span between 15 1/4"W rails. Hanging file racks and dividers available in Gray only.

! Gray only.

NOTES

NOW Tables Finishes

LAMINATES

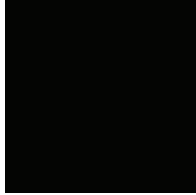

Black
P

Occasional Tables

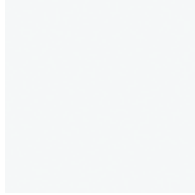

Designer White
LDW1

Between™ Café



Florence Walnut
LFW1

*Between™ Café
Preside®*



Harvest
C

Huddle



Pinnacle
PINC

*Between™ Café and
Nesting
Preside®*



Shaker Cherry
F

Between™ Nesting Tables

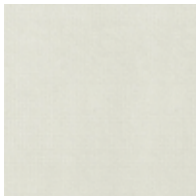

Silver Mesh
B9

*Coordinate™ Tops
Between™ Nesting
Huddle*

PAINT



Black
P/P71

*Between™ Nesting Tables
Coordinate™ Bases
Huddle*



Nickel
P8L

Coordinate™ Bases



Platinum Metallic
T1

Preside®



Textured Silver
PR8

Between™

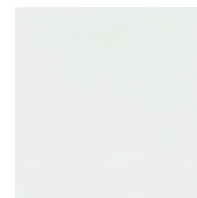

White
PD8

Coordinate™ Bases

NOW Between™ Tables

GSA SIN 33721 EXCEPT AS NOTED



TABLE TOPS

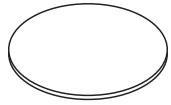

MODEL	DESCRIPTION	SHIP WEIGHT	CUBE	LIST PRICE
HBTRND36.N.LDW1.DW	Round Table Tops 36"W Round Top No grommet, Designer White laminate, Designer White edge	44	4.0	\$345
HBTRND36.N.LFW1.FW	36"W Round Top No grommet, Florence Walnut laminate, Florence Walnut edge	44	4.0	\$345
HBTRND36.N.PINC.PINC	36"W Round Top No grommet, Pinnacle laminate, Pinnacle edge	44	4.0	\$345

NOTES:

- Tops and bases are specified separately.

TABLE BASES

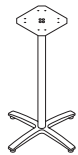

MODEL	DESCRIPTION	SHIP WEIGHT	CUBE	LIST PRICE
HBTTX30S.PR8	X-Base Seated Height X-base for Support of 36" Tops Textured Silver paint	27	5.2	\$324
HBTTX42S.PR8	Standing-Height X-base for Support of 36" Tops Textured Silver paint	30	5.2	\$385

NOTES:

- Seated Height (30³/₄" to top of surface).
- Café Height (42¹/₄" to top of surface).
- Levelers provided on all feet provide ³/₄" of adjustment.
- Tops and bases are specified separately.

NESTING TABLES

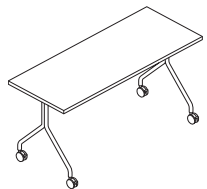

MODEL	DESCRIPTION	SHIP WEIGHT	CUBE	LIST PRICE
HMPT2460NS.N.B9LOFT.P71	Nesting Table 60"W x 24"D No grommet, Silver Mesh laminate, Loft edge, Black paint	81	10.7	\$648
HMPT2460NS.N.FF.P71	60"W x 24"D No grommet, Shaker Cherry laminate, Shaker Cherry edge, Black paint	81	10.7	\$648
HMPT2460NS.N.PINCPINC.P71	60"W x 24"D No grommet, Pinnacle laminate, Pinnacle edge, Black paint	81	10.7	\$648
HMPT2472NS.N.B9LOFT.P71	72"W x 24"D No grommet, Silver Mesh laminate, Loft edge, Black paint	92	12.4	\$685
HMPT2472NS.N.FF.P71	72"W x 24"D No grommet, Shaker Cherry laminate, Shaker Cherry edge, Black paint	92	12.4	\$685
HMPT2472NS.N.PINCPINC.P71	72"W x 24"D No grommet, Pinnacle laminate, Pinnacle edge, Black paint	92	12.4	\$685

OPEN MARKET

NOTES:

- Top and base ship in one carton.

HEIGHT ADJUSTABLE BASES

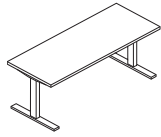

Base shown with work surface attached.



MODEL	DESCRIPTION	SHIP WEIGHT	CUBE	LIST PRICE
HHAB2S2L.P8L	Coordinate™ Height Adjustable Base – 2 Stage 24"D Feet and Worksurface Brackets Nickel finish	63	2.4	\$1006
HHAB2S2L.P71	24"D Feet and Worksurface Brackets, Black finish	63	2.4	\$1006
HHAB2S2L.PD8	24"D Feet and Worksurface Brackets, White finish	63	2.4	\$1006

NOTES: Base is a dual motor 2-stage design with standard anti-collision. Legs raise from 25⁵/₈" to 45¹/₄". Base telescopes to accommodate any rectangular work surface between 24"D x 48"W and 30"D x 72"W. Supports weight capacity of 250 lbs. (excluding work surface weight). Comes standard with one-touch, four memory controller with digital display; no specification needed, available in black finish only. **HON 5-Year Limited Warranty.**

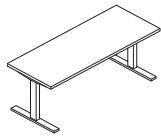

Base shown with work surface attached.



HHAB3S2L.P8L	Coordinate™ Height Adjustable Base – 3 Stage 24"D Feet and Worksurface Brackets Nickel finish	67	2.4	\$1120
---------------------	------------------------------------------------------------------------------------------------------------	----	-----	---------------

NOTES: Base is a dual motor 3-stage design with standard anti-collision. Legs raise from 21⁵/₈" to 47³/₄". Base telescopes to accommodate any rectangular work surface between 24"D x 48"W and 30"D x 72"W. Supports weight capacity of 250 lbs. (excluding work surface weight). Comes standard with one-touch, four memory controller with digital display; no specification needed, available in black finish only. **HON 5-Year Limited Warranty.**

NOTES:

- ! Telescoping horizontal frame will extend just over 2" from underside of the work surface.
- ! Coordinate™ Height Adjustable Bases not compatible with 36"D rectangular work surfaces.

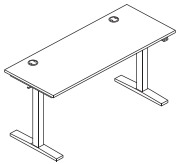

Base shown with work surface attached.

HHABETA2S2L.SVR.X.UD	Coordinate™ Easy to Assemble 2-Leg Height Adjustable Base – 2 Stage 24"D Feet Nickel finish, Basic Up/Down control.	77	4.0	\$728
-----------------------------	----------------------------------------------------------------------------------------------------------------------------------	----	-----	--------------

NOTES: Base telescopes to accommodate rectangular work surfaces between 24"D x 48"W and 30"D x 60"W. Supports weight capacity of 180 lbs. Control Box: 100-240V, 3.6A, 50/60Hz, 400W. 9' grounded power cord. 1²/₅" per second travel speed. **HON 5-Year Limited Warranty.**

DESKTOP RISER & SIT-TO-STAND DEVICES

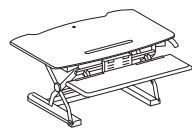

MODEL	DESCRIPTION	SHIP WEIGHT	CUBE	LIST PRICE
HBXRISER.BLK	Portable Desktop Riser 31"D x 4 ¹ / ₂ "-16 ¹ / ₂ "H x 35"W Black finish	54	4.1	\$619
HBXRISER.WHT	31"D x 4 ¹ / ₂ "-16 ¹ / ₂ "H x 35"W White finish	54	4.1	\$619

NOTES:

- Max loading capacity is 33 lbs for the desktop riser surface and 4 lbs for the keyboard tray.
- **HON 5-Year Limited Warranty.**

- ! Not intended for use on mobile workstations.

WORKSURFACES

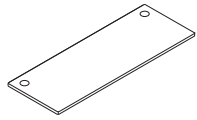

MODEL	DESCRIPTION	SHIP WEIGHT	CUBE	LIST PRICE
	Systems Rectangle Worksurfaces for Height Adjustable Bases			
HHAW2448P.B9.LOFT.LOFT	46¾"W x 23"D Silver Mesh laminate, Loft edge, Loft grommet	58	3.3	\$429
HHAW2448P.PINC.PINC.LOFT	46¾"W x 23"D Pinnacle laminate and edge, Loft grommet	58	3.3	\$429
HHAW2448P.LFW1.FW.LOFT	46¾"W x 23"D Florence Walnut laminate and edge, Loft grommet	58	3.3	\$429
HHAW2448P.LDW1.DW.LOFT	46¾"W x 23"D Designer White laminate and edge, Loft grommet	58	3.3	\$429
HHAW2460P.B9.LOFT.LOFT	58"W x 23"D Silver Mesh laminate, Loft edge, Loft grommet	70	4.0	\$499

NOTES: Systems Rectangle Worksurfaces for Height Adjustable Bases designed for use in panel systems. Worksurface is 2" shorter in width and 1" shorter in depth to provide clearance between panels and other worksurfaces.

⚠ Must be used as worksurfaces on Coordinate™ Height Adjustable Bases within Panel Systems, as these are 1" shorter in width on each side to provide clearance between panels and other worksurfaces.

⚠ Only offered with grommets.

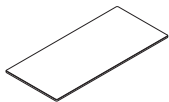

	30"D Height Adjustable Worksurfaces			
HHAW3060PN.B9.LOFT	60"W x 30"D Silver Mesh laminate, Loft edge	101	4.8	\$544
HHAW3060PN.PINC.PINC	60"W x 30"D Pinnacle laminate and edge	101	4.8	\$544
HHAW3060PN.LFW1.FW	60"W x 30"D Florence Walnut laminate and edge	101	4.8	\$544
HHAW3060PN.LDW1.DW	60"W x 30"D Designer White laminate and edge	101	4.8	\$544

NOTES: Worksurfaces are constructed of laminate on 1/8" solid core high-performance particleboard.

⚠ All worksurfaces load tested to BIFMA standards.

⚠ **T-mold cannot be used with Empower® — edgeband must be used.**

⚠ Stack-on storage cannot be used on Empower® benching.

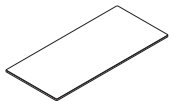

	30"D Worksurface with Edgeband			
HWR3060PN.B9.LOFT	60"W x 30"D Silver Mesh laminate, Loft edge	70	4.0	\$520
HWR3060PN.PINC.PINC	60"W x 30"D Pinnacle laminate and and edge	70	4.0	\$520
HWR3060PN.LFW1.FW	60"W x 30"D Florence Walnut laminate and edge	70	4.0	\$520
HWR3060PN.LDW1.DW	60"W x 30"D Designer White laminate and edge	70	4.0	\$520

NOTES: Worksurfaces are constructed of laminate on 1/8" solid core high-performance particleboard.

⚠ All worksurfaces load tested to BIFMA standards.

⚠ **T-mold cannot be used with Empower® — edgeband must be used.**

⚠ Stack-on storage cannot be used on Empower® benching.





MULTI-PURPOSE TABLE TOPS

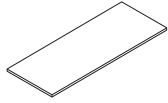

MODEL	DESCRIPTION	SHIP WEIGHT	CUBE	LIST PRICE
HMT2460G.N.B9.P	Rectangular Edgeband Table Tops 60"W x 24"D No grommet, Silver Mesh laminate, Black edge	57	4.5	\$389
HMT2460G.N.C.P	60"W x 24"D No grommet, Harvest laminate, Black edge	57	4.5	\$389

MULTI-PURPOSE TABLE BASES

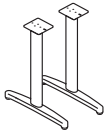

MODEL	DESCRIPTION	SHIP WEIGHT	CUBE	LIST PRICE
HMBTLEG24.C.P	Fixed Height T-Leg Base (Includes 2 T-legs) Casters, Black paint	14	3.6	\$426
<p>! When specifying T-legs with the 60"W Huddle worksurface, add external channel model HLSLZ5SC60, reference page 44.</p>				



HMBFLIP24L.C.P	Flip-top Base (Includes 1 Complete Base) Casters, Black paint	27	4.1	\$626
-----------------------	-------------------------------------------------------------------------	----	-----	--------------

NOW Huddle Bundles

QTY	DESCRIPTION	MODEL	LIST PRICE	PRICE EXTENSION
1	Rectangular Edgeband Table Top 60"W x 24"D	HMT2460G.N.B9.P	\$389	\$389
1	Flip-Top Base	HMBFLIP24L.C.P	\$626	\$626
No grommet, Silver Mesh laminate, Black edge, Casters, Black base paint			TOTAL:	\$1009

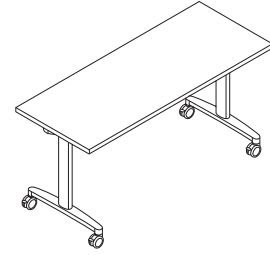

HHUD2460FLB9

QTY	DESCRIPTION	MODEL	LIST PRICE	PRICE EXTENSION
1	Rectangular Edgeband Table Top 60"W x 24"D	HMT2460G.N.B9.P	\$389	\$389
1	Fixed Height T-Leg Base	HMBTLEG24.C.P	\$426	\$426
No grommet, Silver Mesh laminate, Black edge, Casters, Black base paint			TOTAL:	\$810

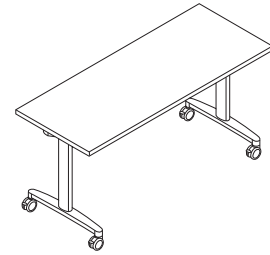

HHUD2460FXB9

QTY	DESCRIPTION	MODEL	LIST PRICE	PRICE EXTENSION
1	Rectangular Edgeband Table Top 60"W x 24"D	HMT2460G.N.C.P	\$389	\$389
1	Flip-Top Base	HMBFLIP24L.C.P	\$626	\$626
No grommet, Harvest laminate, Black edge, Casters, Black base paint			TOTAL:	\$1009

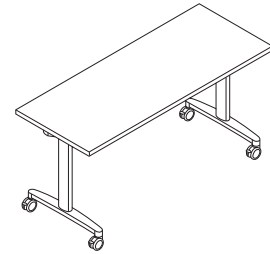

HHUD2460FLC

QTY	DESCRIPTION	MODEL	LIST PRICE	PRICE EXTENSION
1	Rectangular Edgeband Table Top 60"W x 24"D	HMT2460G.N.C.P	\$389	\$389
1	Fixed Height T-Leg Base	HMBTLEG24.C.P	\$426	\$426
No grommet, Harvest laminate, Black edge, Casters, Black base paint			TOTAL:	\$810

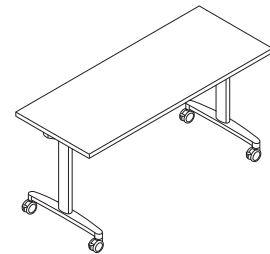

HHUD2460FXC

ⓘ External channel not included in the bundle, must be specified separately. When ordering T-legs with the 60"W Huddle worksurface, add external channel model **HLSLZ55C60**. Reference page 44.

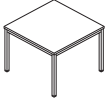
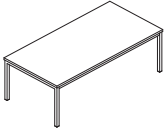

CONTEMPORARY OCCASIONAL TABLES

	MODEL	DESCRIPTION	SHIP WEIGHT	CUBE	LIST PRICE
	HML8851.P	Laminate Corner Table 24"W x 24"D x 17½"H Black laminate	24 Ⓔ	1.7	\$201
	HML8852.P	Laminate Coffee Table 48"W x 24"D x 15½"H Black laminate	38 Ⓔ	3.1	\$251

NOTES:

- Silver frame.
- **HON 5-Year Limited Warranty.**

NOW Preside® Tables

GSA SIN 33721



Icon Legend on page 7

TABLE TOPS

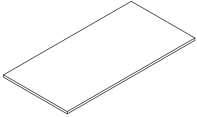
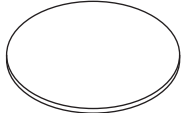
	MODEL	DESCRIPTION	SHIP WEIGHT	CUBE	LIST PRICE
	HTLC3672.GPINC.N.PINC	Laminate Rectangle Table Tops 72"W x 36"D Pinnacle laminate and edge	90	7.9	\$624
	HTLC3672.GFW.N.LFW1	72"W x 36"D Florence Walnut laminate and edge	90	7.9	\$624
	HTLD48.GPINC.N.PINC	Laminate Round Table Tops 48" Round Top Pinnacle laminate and edge	66	6.3	\$529
	HTLD48.GFW.N.LFW1	48"W Round Top Florence Walnut laminate and edge	66	6.3	\$529

NOTES:

- Tops and bases are specified separately.

TABLE BASES

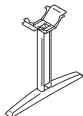
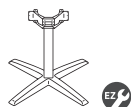
	MODEL	DESCRIPTION	SHIP WEIGHT	CUBE	LIST PRICE
 	HTTLEG.T1	Aluminum T-Leg Base For 72"W Tops Platinum Metallic paint	26	3.5	\$648
	HTXLEG.T1	Aluminum X-Base For 36" Tops Platinum Metallic paint	16	3.5	\$521

NOTES:

- HTXLEG allows wires to pass through the center of the leg.

LAMINATES

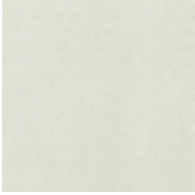

Silver Mesh

B9

Motivate®
SmartLink®

SHELL/PLASTICS



Onyx

ON

SmartLink®



White

G1

SmartLink®

PAINTS

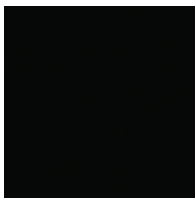

Black
P/BLCK

Motivate®



Platinum Metallic

T1

SmartLink®

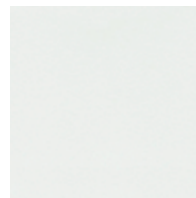

Designer White

PJW

SmartLink®

MOTIVATE® PRESENTATION CART



MODEL

DESCRIPTION

**SHIP
WEIGHT**

CUBE

LIST PRICE

HMVPCA1-1830G.C.B9.P.BLCK

Presentation Cart, Concave Front, Seated Height Adjustable Leg
 18"D x 30"W x 27 1/2" - 34 1/2"H, 2mm Edge
 Black casters, Silver Mesh laminate, Black edge, Black paint

40

3.9

\$1201

NOTES: Presentation Cart tops are 1/8" thick with a concave user side.



HMVPCSS-4C4C.BLCK

Presentation Cart, Storage Shelves
 Double, 4" Closed Back / 4" Closed Back
 Black paint

18

2.6

\$201



SMARTLINK® STUDENT DESK

**MODEL****DESCRIPTION****SHIP WEIGHT****CUBE****LIST PRICE PER CARTON****HLDV-M3A.E.G1.T1**

Student Desk, Adjustable Height, Hard Plastic Top
28"W x 28"W, User side 36 1/4"W
Adjustable: 23"-33" height adjustment range

Hard surface glide, White plastic top, Platinum Metallic paint

59

12.5

\$606

SPECIFICATION TIP: Consider available kneespace when specifying under desk storage Wire Book Box. Available kneespace will vary significantly given set desk height. Use the following example to calculate the available and usable kneespace.

EXAMPLE: HLDV-M3A Student Desk, HLDA-15 Wire Book Box

(user set desk height - top thickness - seat height = available kneespace)

(29"H - 1" thickness - 18" seat height = 10" available kneespace)

(available kneespace - book basket/box height = usable kneespace)

(10" available kneespace - 5" basket height = 5" usable kneespace)

NOTES: Accepts book basket (HLDA-15) installation without repositioning crossbar.

Student Desks are ordered and shipped two (2) desks per carton. Upper leg and cross-brace ship attached. Lower adjustable legs ship unattached for field installation. Pricing shown is per carton. Ordering two of model HLDV-M3A will result in 2 cartons being shipped, giving you 4 desks.

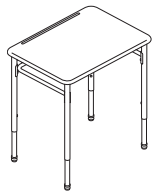
**HLDV-MRECT2026A.G1.T1**

Rectangle Student Desk, Adjustable Height, Hard Plastic Top
20"W x 26"W
Adjustable: 23"-33" height adjustment range

Hard surface glide, White plastic top, Platinum Metallic paint

57

9.2

\$606

NOTES: Accepts book basket (HLDA-15) installation without repositioning crossbar.

Student Desks are ordered and shipped two (2) desks per carton. Legs and cross-brace ship attached. Pricing shown is per carton. Ordering two of model HLDV-MRECT2026A will result in 2 cartons being shipped, giving you 4 desks.

NOTES:

- Upper leg is painted, lower leg standard chrome finish on Adjustable Height models.
- Non-handed desk top constructed of 3/4" hard plastic.
- Hard plastic tops include pencil grooves.
- Nylon swivel glides are standard on Adjustable Height models.
- Adjustable Height models ship fully assembled and have upper leg and cross-brace installed. The lower leg ships unattached for field installation.
- 29.60" distance between legs on user side. Outside distance between legs is 23 3/8".
- Accepts optional backpack hooks (HCLA65).
- Book boxes are only available as an accessory for field installation on Value Series desks.

SMARTLINK® STUDENT DESK ACCESSORIES

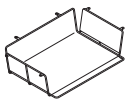
**MODEL****DESCRIPTION****SHIP WEIGHT****CUBE****LIST PRICE****HLDA-15.T1**

Wire Book Box (4 per carton)
19 1/2"W x 13"W x 5"H, Platinum finish

15

2.0

\$261

NOTES: Attaches to bottom of desk with 6 screws, included. Field installed. For use on model HLD-M3A and HLDV-MRECT2026A. Features integrated, full-width pencil holder. Bent wire and perforated steel construction for durability and visibility.

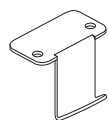
**MODEL****DESCRIPTION****SHIP WEIGHT****CUBE****LIST PRICE****HCLA65.X****Backpack Hook (10 per carton)**

10

0.1

\$95**OPEN MARKET**

NOTES: Attaches to the bottom of desk with (2) screws, included.

SMARTLINK® MOBILE STORAGE CABINETS

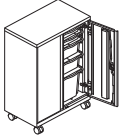

	MODEL	DESCRIPTION	SHIP WEIGHT	CUBE	LIST PRICE
	HLVMSC4330R.L.PJW	Mobile Storage Cabinet with Bins 18"D x 30"W x 32 1/4"H Designer White paint	171.6	18.0	\$1597
	HLVMSC4330R.L.TI	18"D x 30"W x 32 1/4"H Platinum Metallic paint	171.6	18.0	\$1645

OPEN MARKET

NOTES:

- Full radius "R" handle on doors.
- Units include 2 locking and 2 non-locking casters.
- Equipped with HON "One Key" interchangeable core removable locks.

SMARTLINK® TEACHER STATION

	MODEL	DESCRIPTION	SHIP WEIGHT	CUBE	LIST PRICE
 	HLTV2460T-3.B9.K.TI	Teacher Station 60"W x 24"D x 30"H, Box/Box/File Silver Mesh laminate, Platinum T-mold, Platinum Metallic paint	158	14.1	\$1377

NOTES:

- Tops/Bases are Laminate with T-mold edge.
- Standard with Heavy-duty 3", 360-degree swivel casters, 4-locking, 4-non-locking.
- Storage options include: Locking box/box/file.
- Kneewell space accommodates separately specified and field installed non-locking center drawer and CPU holders.
- D-shape top encourages conferencing and provides ample work and conference area.
- Right or left assembled in the field.
- Modesty specified separately.
- Power modules can be ordered separately and mounted to the desk .



SMARTLINK® STUDENT SEATING

HSS4L-18B

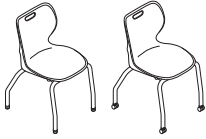

18”H 4-Leg Chair

Armless

DIMENSIONS

Seat Depth:	16¼	Ship Weight:	58
Seat Width:	16½	Cube:	15.6
Back Width:	15¾		
Back Height:	13¾		

MODEL / DESCRIPTION

HSS4L-18B.E.ON.PLAT

Nickel Steel glide, Onyx shell, Textured Platinum Metallic frame

LIST PRICE

\$583

SINGLE UNIT

\$145.75

NOTES:

- High strength tubular steel frame.
- Seat Shell is one-piece injection molded.
- Models accept Wire Storage Basket model HSSA-WB1618.
- 4-Leg models stack 5-high on floor.
- Durable textured powder coated paint finish or chrome option finish.
- ⊕ SmartLink® 4-Leg Chairs are ordered and shipped four (4) chairs per carton. Pricing shown is per carton. Each set of four chairs (one carton) must have the same shell/frame color combination. Ordering 2 of Model HSS4L-18B will result in 2 cartons being shipped, giving you 8 chairs.

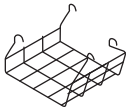

MODEL

HSSA-WB1618

DESCRIPTION

Wire Storage Basket (4 per carton)
15 ¾”D x 12 ¼”W x 9 ¾”H
Chrome finish

SHIP WEIGHT

14

CUBE

1.6

LIST PRICE

\$140

- ⓘ Chairs cannot be stacked when utilizing Wire Storage Basket.
- ⓘ Not compatible with 4-Leg Stools or Cantilever Chairs.

HSSTK-18B

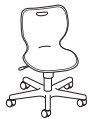

18”H Task Swivel Chair, Pneumatic Seat Height Adjustment

DIMENSIONS

Seat Depth:	16¼	Ship Weight:	23
Seat Width:	16½	Cube:	5.2
Back Width:	15¾		
Back Height:	13¾		

MODEL / DESCRIPTION

HSSTK-18B.H.ON

Black Hard caster, Onyx shell, Black frame

LIST PRICE

\$317

HSSST-18B



18”H Task Swivel Stool, Pneumatic Seat Height Adjustment, Footring Adjustment

DIMENSIONS

Seat Depth:	16¼	Ship Weight:	28
Seat Width:	16½	Cube:	12.8
Back Width:	15¾		
Back Height:	13¾		

MODEL / DESCRIPTION

HSSST-18B.H.ON

Black Hard caster, Onyx shell, Black frame

LIST PRICE

\$390

NOTES:

- Seat Shell is one-piece injection molded.
- Task Swivel Chair has a pneumatic seat height adjustment.
- Stool has an adjustable footring.
- Swivel Task Chair and Stool ship one per carton.

NOTES

NOW Workplace Tools Finishes

PAINT



Black
P71
Acrylic Screens



Textured Black
P6P
Foot Pulls

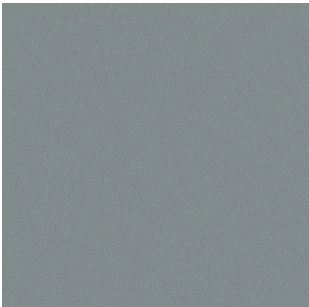

Textured Titanium
P8V
Foot Pulls



Titanium
P8T
*Hand Sanitizer Stand
PPE Stand
Universal Panel Stackers*

CHAIR MATS

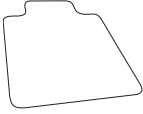
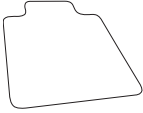
	MODEL	DESCRIPTION	SHIP WEIGHT	CUBE	LIST PRICE
	HCM4660LS	Lipped Chair Mat with Studs 60"W x 46"D	13.9	1.0	\$146
	HCM3648LS	48"W x 36"D	8.8	0.6	\$88
	HCM4660LN	Lipped Chair Mat without Studs 60"W x 46"D	13.2	0.5	\$146
	HCM3648LN	48"W x 36"D	8.3	0.3	\$88

NOTES:

- Clear finish only.
- Available in 60"W x 46"D and 48"W x 36"D sizes.
- Features rectangle and lipped shapes.
- Available with studs for carpet and without studs for hard-surface floors.
- Ships rolled.
- **HON 5-Year Limited Warranty.**

 Clear finish only. No specification needed.

MONITOR ARMS

	MODEL	DESCRIPTION	SHIP WEIGHT	CUBE	LIST PRICE
	HBSMAUSB	Single Monitor Arm with 2 USB Ports	38.6	2.4	\$255



NOTES:

Monitor Arms

- For use on 17"-30" monitors; up to 17.6 lbs.
- Built-in dual USB 3 ports.
- Height adjusts to 17" tall.
- Monitor tilt and swivel capability.
- Ships with hardware for grommet or clamp attachment to worksurface.
- Arms feature double extension, allowing 20"+ of back and forth movement.
- Cable management on both pole and arm assemblies.
- **HON 5-Year Limited Warranty.**

 Cannot be used in Empower® height adjustable applications.

MONITOR ARMS

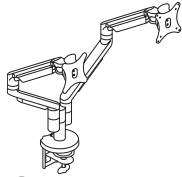

ABI

MODEL	DESCRIPTION	SHIP WEIGHT	CUBE	LIST PRICE
HMASD.SVR	Dual Dynamic Monitor Arm Silver finish	17.0	1.1	\$900
<ul style="list-style-type: none"> • 150° of rotation at base with optional 360° rotation. • Arms extend 22" and retract up to 3". • Monitor mount rotates 180° and tilts +/-30°. • Monitor can be rotated from landscape to portrait position. <p> Arms hold monitors from 6.2-18 lbs. Optional counterweight HPACW available to support monitors as low as 5 lbs.</p>				

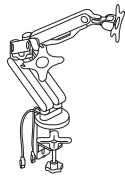

HBDMAUSB	Dual Monitor Arm with 2 USB Ports	41.9	2.6	\$383
<p>NOTES: Easy adjustment. Height adjusts to 17" tall. Monitor tilt and swivel capability. Enclosed cable management. Grommet or desktop mounting. Clean appearance. In some applications the Monitor Arms may extend 12 or more inches into the worksurface. HON 5-Year Limited Warranty.</p> <p> No specification needed.</p>				

HAND SANITIZER STAND & MOUNTS



ABI

MODEL	DESCRIPTION	SHIP WEIGHT	CUBE	LIST PRICE
HHC-SANSTND.P8T	Hand Sanitizer Station Mounting Area: 6"W x 12"H Base: 12"W x 16"H Titanium finish	15.0	6.1	\$259
<p>NOTES: Freestanding. Stand is compatible with most manufacturers' automatic hand sanitizer dispensers, sold separately. No assembly required. Metal base for added stability.</p>				

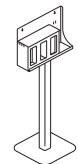

ABI

HHC-PPESTND.P8T	Freestanding PPE Stand Mounting Area: 5"W x 5 1/4"D x 10"H Titanium finish	39.0	7.7	\$561
<p>NOTES: Freestanding. 3 closed compartments fit most manufacturers' boxed PPE, including gloves, masks, wipes, and tissues. Closed compartments have adjustable back to best fit. Each closed compartment measures 5"W x 5 1/4"D x 10"H. Open space can accommodate most manufacturers' automatic hand sanitizer dispensers, hand sanitizer bottles, or wipe containers, sold separately.</p>				

UNIVERSAL PANEL STACKERS

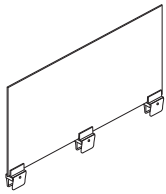

MODEL	DESCRIPTION	SHIP WEIGHT	CUBE	LIST PRICE
	Universal Panel Stackers			
HPNLSTACK2224.G.P8T	22"H x 22"W, Titanium finish	17.0	1.9	\$388
HPNLSTACK2230.G.P8T	22"H x 28"W, Titanium finish	20.0	2.4	\$434
HPNLSTACK2236.G.P8T	22"H x 34"W, Titanium finish	23.0	2.9	\$485
HPNLSTACK2242.G.P8T	22"H x 40"W, Titanium finish	26.0	3.3	\$537
HPNLSTACK2248.G.P8T	22"H x 46"W, Titanium finish	29.0	3.8	\$599
HPNLSTACK2254.G.P8T	22"H x 52"W, Titanium finish	32.0	4.3	\$629
HPNLSTACK2260.G.P8T	22"H x 58"W, Titanium finish	35.0	4.7	\$651

NOTES:

- Can be used on any panel system between 1.975" and 3.450" thick.
- Glass is undersized by 2".
- Stackers can span multiple panels.
- Panel stackers will work with both flat trim and radius trim.
- Screens ship with brackets included.





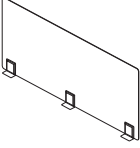
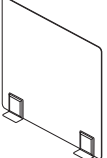
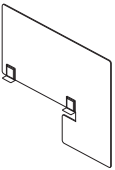

ACRYLIC SCREENS

	MODEL	DESCRIPTION	SHIP WEIGHT	CUBE	LIST PRICE
	HACRYSCRN2548.P71	Acrylic Table Screen 25"H x 45½"W, for 48"W Surfaces, Black frame	15.0	6.7	\$637
	HACRYSCRN2554.P71	25"H x 51½"W, for 54"W Surfaces, Black frame	18.0	7.4	\$668
	HACRYSCRN2560.P71	25"H x 57½"W, for 60"W Surfaces, Black frame	20.0	8.2	\$702
	HACRYSCRN2566.P71	25"H x 63½"W, for 66"W Surfaces, Black frame	21.0	9.0	\$737
	HACRYSCRN2524.P71	Acrylic Table Screen 25"H x 21"D, for 24"D Surfaces, Black frame	6.0	3.7	\$441
	HACRYSCRN2530.P71	25"H x 25"D, for 30"D Surfaces, Black frame	8.0	4.2	\$462
	HACRYSCRN2536.P71	25"H x 34"D, for 36"D Surfaces, Black frame	11.0	5.3	\$485
	HACRYEXSCRN2042.P71	Acrylic Extended Screen 20' 'H x 37' 'D, for 30' 'D Surfaces, Black frame	9.0	6.3	\$559
	HACRYEXSCRN2536.P71	25'H x 33½"W, for 24' 'D Surfaces, Black frame	12.0	6.6	\$585

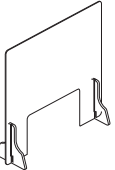

NOTES:

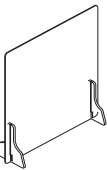
- Screens mount by using double stick tape, which provides the ability to mount to any surface.
- Extended Screen can be used on all HON products including Voi®, Empower®, and Coordinate™ Height Adjustable Tables. Extended screen can also be used on any 2½" thick or under surface with 5"D clear space underneath.
- Minimum mounting clearance on top of worksurface at each bracket location is 3"W x 1½"D.

PLEXI-GLASS SCREENS

	MODEL	DESCRIPTION	SHIP WEIGHT	CUBE	LIST PRICE
	HHC-TASCRN3630	Plexi-Glass Screens with Pass-Thru Opening 36"H x 30"W	13 	1.4	\$465
	HHC-TASCRN3636	36"H x 36"W	15 	1.1	\$475
	H-TASCRN3630	Plexi-Glass Screens without Pass-Thru Opening 36"H x 30"W	13 	1.4	\$465
	H-TASCRN3636	36"H x 36"W	15 	1.1	\$475

NOTES:

- Screens ship with two black stands each.
- Screen stand is 11"D x 12"H.
- Pass-thru opening is 20"W x 12"H.
-  Easy to assemble, no tools required.
-  Unit is freestanding and does not need to be fixed to any surface.

TASK LIGHTS

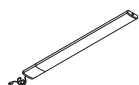

MODEL	DESCRIPTION	SHIP WEIGHT	CUBE	LIST PRICE
HLED17AS	LED Task Lights 17" LED Light with Power Supply (Single)	1.2	0.05	\$420
HLED31AS	31" LED Light with Power Supply (Single)	1.5	0.09	\$564

NOTES: To use the daisy chain application, must start with model HLED17A or HLED31A. No finish specification required. Attaches magnetically to underside of overhead storage or attaches with provided screws. Occupancy sensor attaches to a single or starter LED light and will automatically turn the light off after no motion is detected for 30 minutes. Just like all the LED light models, the occupancy sensor features a soft-touch on/off switch. LED task lights have a lifetime of 50,000 hours and have a dimmer feature that allows the user to adjust the amount of light output.



MODEL	DESCRIPTION	SHIP WEIGHT	CUBE	LIST PRICE
HH870930	Recessed Task Lights • Color: Black. • Slim profile design. • Mount to stack-on storage and wall mounted storage cabinets. • Electronic ballast for increased energy efficiency. • T5 bulb, included, which contains less mercury. • 9-foot black cord and switch off right rear corner. 22 ⁷ / ₈ "W x 3 ³ / ₁₆ "D x 1 ¹ / ₈ "H	7.0	0.60	\$231
HH870942	34 ⁵ / ₈ "W x 3 ³ / ₁₆ "D x 1 ¹ / ₈ "H	10.0	0.90	\$250

NOTES:

- Choose from a variety of task lights that mount under overhead storage or sit on the worksurface.
- LED Task Lights have a wide range of motion for precise placement.

HANDS-FREE DOOR PULLS

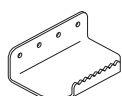

MODEL	DESCRIPTION	SHIP WEIGHT	CUBE	LIST PRICE
HHC-FOOTPULL5.P6P	Metal Foot Pull, Pack of 5 Textured Black finish	8	0.7	\$334
HHC-FOOTPULL5.P8V	Metal Foot Pull, Pack of 5 Textured Titanium finish	8	0.7	\$334
HHC-FOOTPULL15.P6P	Metal Foot Pull, Pack of 15 Textured Black finish	23	0.7	\$936
HHC-FOOTPULL15.P8V	Metal Foot Pull, Pack of 15 Textured Titanium finish	23	0.7	\$936

NOW Seating Fabrics and Finishes

FABRICS



Black
ACCF10



Centurion Black
CU10



Black
GA10



Black
ES10

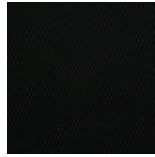

Black
MM10



Black
VM10



Black
VA10



Black
LH10

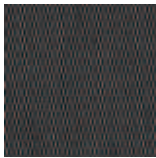

Black Mesh
MST3



Navy
VA90



Apex Navy
APX13



Apex Basalt
APX25



Light Gray
GRY01

LEATHER/VINYL

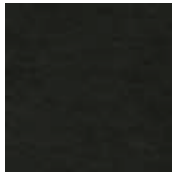

Black Leather
SB11



Black
PWST11



Denver Leather
Black
SS11

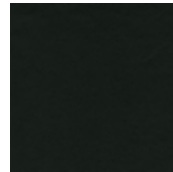

Contourett
Black
UR10

SHELL COLORS



Onyx
ON

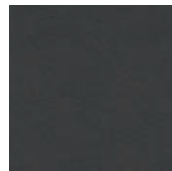

Lava
LA

! All fabrics not available on all series. See product listings for available finishes.

ACCOMMODATE® GUEST CHAIRS

HSGS6

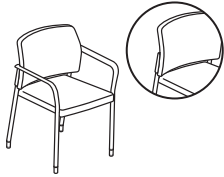

GUEST

Ships 2 per Carton

DIMENSIONS

Depth:	22¼	Seat to Floor Height:	18¼
Height:	31½	Usable Seat Depth:	17
Seat Depth:	20¾	Ship Weight (with arms):	50
Seat Width:	17½	Ship Weight (armless):	48
Back Width:	19¾	Cube (with arms):	15.8
Back Height:	16¼	Cube (armless):	15.8
Width (with arms):	23½	COM (per 2 pack):	3.0
Width (armless):	19¾	Weight Rating:	300 lbs.
Arm Width:	20¼		

MODEL / DESCRIPTION

HSGS6.F.B.UR10.BLCK

Fixed arms, Hard casters and Nylon glides, Contourett Black upholstery, Black frame

LIST PRICE

\$870



SIN 33721

ASSEMBLE™ NESTING/STACKING CHAIRS

HVL304



NESTING/STACKING

Upholstered Seat and Mesh Back
Casters
Armless
Ships 2 per Carton

DIMENSIONS

Depth:	24	Seat to Floor Height:	17
Width:	24	Usable Seat Depth:	17
Height:	34¾	Ship Weight:	57
Seat Depth:	17	Cube:	9.0
Seat Width:	18	Weight Rating:	250 lbs.
Back Width:	16¾		

MODEL / DESCRIPTION

HVL304.VA10.T

Black fabric, Black frame

HVL304.VA10.X

Black fabric, Silver frame

LIST PRICE

\$573

SINGLE UNIT

\$286.50



OPEN MARKET

HVL314



NESTING/STACKING

Upholstered Seat and Mesh Back
Casters
Arms
Ships 2 per Carton

DIMENSIONS

Depth:	24	Arm Width:	18
Width:	24	Seat to Floor Height:	17
Height:	34¾	Usable Seat Depth:	17
Seat Depth:	17	Ship Weight:	57
Seat Width:	18	Cube:	9.2
Back Width:	16¾	Weight Rating:	250 lbs.

MODEL / DESCRIPTION

HVL314.VA10.T

Black fabric, Black frame

HVL314.VA10.X

Black fabric, Silver frame

LIST PRICE

\$599

SINGLE UNIT

\$299.50



OPEN MARKET



CIRCULATE™ CLUB/LOUNGE

HVL871

CLUB CHAIR

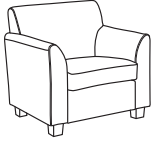

DIMENSIONS

Depth:	28¾	Arm Width:	21½
Width:	33	Seat to Floor Height:	18½
Height:	32	Usable Seat Depth:	21
Seat Depth:	21	Ship Weight:	51
Seat Width:	21½	Cube:	20.7
Back Width:	30	Weight Rating:	250 lbs.
Back Height:	18½		

MODEL / DESCRIPTION

HVL871.SB11

Black SofThread™ Leather

LIST PRICE

\$1305

HVL872

LOVE SEAT

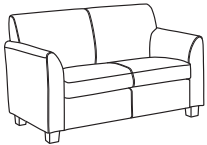

DIMENSIONS

Depth:	28¾	Arm Width:	42
Width:	53½	Seat to Floor Height:	18½
Height:	32	Usable Seat Depth:	21
Seat Depth:	21	Ship Weight:	76
Seat Width:	42	Cube:	33.1
Back Width:	50	Weight Rating:	250 lbs.
Back Height:	18½		

MODEL / DESCRIPTION

HVL872.SB11

Black SofThread™ Leather

LIST PRICE

\$1655

HVL873

SOFA

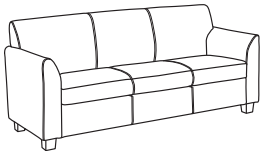

DIMENSIONS

Depth:	28¾	Arm Width:	61½
Width:	73	Seat to Floor Height:	18½
Height:	32	Usable Seat Depth:	21
Seat Depth:	21	Ship Weight:	122
Seat Width:	61½	Cube:	45.0
Back Width:	70	Weight Rating:	250 lbs.
Back Height:	18½		

MODEL / DESCRIPTION

HVL873.SB11

Black SofThread™ Leather

LIST PRICE

\$2068



CLIENT™ GUEST CHAIR

HVL693



GUEST CHAIR

Sled Base
Padded Arms

DIMENSIONS

Depth:	26	Arm Width:	18½
Width:	24¾	Seat to Floor Height:	18¼
Height:	33½	Usable Seat Depth:	18¼
Seat Depth:	18¼	Ship Weight:	38
Seat Width:	20¾	Cube:	5.2
Back Width:	21	Weight Rating:	250 lbs.
Back Height:	16¼		

MODEL / DESCRIPTION

HVL693.SB11
Black SofThread™ Leather

LIST PRICE

\$387



CLIQ™ TASK CHAIRS

HCLQT



LIGHT TASK CHAIR

Pneumatic
Swivel
Synchro-tilt
Weight-activated
Tilt Lock

DIMENSIONS

Depth:	27	Seat to Floor Height	
Width:	27	(Task Cylinder):	17-22
Height:	41	Usable Seat Depth:	17
Seat Depth:	17	Ship Weight:	45
Seat Width:	19¼	Cube:	10.7
Back Width:	19¼	Weight Rating:	300 lbs.
Back Height:	21		

MODEL / DESCRIPTION

HCLQT.WO.TC2.F.S.IM.CU10.NL.SB.T

Weight-activated control, Fixed arms, All-Surface casters, Black mesh, Centurion Black fabric, Black frame

LIST PRICE

\$625

HCLQT.WO.TC2.F.S.IM.APX13.NL.SB.T

Weight-activated control, Fixed arms, All-Surface casters, Black mesh, Apex Navy fabric, Black frame

\$625

HCLQT.WO.TC2.F.S.IM.APX25.NL.SB.T

Weight-activated control, Fixed arms, All-Surface casters, Black mesh, Apex Basalt fabric, Black frame

\$625

HCLQT.WO.TC2.F.S.IM.CU10.NL.SB.DW

Weight-activated control, Fixed arms, All-Surface casters, Designer White mesh, Centurion Black fabric, Designer White frame

\$660

HCLQT.WO.TC2.F.S.IF.APX25.NL.SB.DW

Weight-activated control, Fixed arms, All-Surface casters, Black mesh, Apex Basalt fabric, Designer White frame

\$660

CONVERGENCE® STANDARD TASK CHAIRS

HCT1MM



MID-BACK TASK

Mesh Back
Pneumatic
Swivel
Tilt Tension
Tilt Lock
Adjustable Lumbar Support

DIMENSIONS

Depth:	27½	Adjustable Arms Width:	20
Width:	27¾	Seat to Floor Height:	15¾-20
Height:	42	Usable Seat Depth:	17-19
Seat Depth:	19	Ship Weight:	44
Seat Width:	20	Cube:	5.8
Back Width:	18	Weight Rating:	275 lbs.
Back Height:	22		

MODEL / DESCRIPTION

HCT1MM.Y1.A.H.M.APX13.AL.SB.T

Simple synchro-tilt with seat slide, Height and width adjustable arms, Hard casters, Mesh back, Apex Navy fabric, Adjustable lumbar, Standard base, Black frame

LIST PRICE

\$455

HCT1MM.Y1.A.H.M.APX25.AL.SB.T

Simple synchro-tilt with seat slide, Height and width adjustable arms, Hard casters, Mesh back, Apex Basalt fabric, Adjustable lumbar, Standard base, Black frame

\$455

HCT1MM.Y1.A.H.M.CU10.AL.SB.T

Simple synchro-tilt with seat slide, Height and width adjustable arms, Hard casters, Mesh back, Centurion Black fabric, Adjustable lumbar, Standard base, Black frame

\$455

HCT1MM.Y1.A.H.M.UR10.AL.SB.T

Simple synchro-tilt with seat slide, Height and width adjustable arms, Hard casters, Mesh back, Contourett Black upholstery, Adjustable lumbar, Standard base, Black frame

\$455



CORRAL™ CONTEMPORARY LOUNGE

HVL887

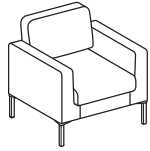

CLUB CHAIR

DIMENSIONS

Depth:	28	Arm Width:	22½
Width:	31½	Seat to Floor Height:	17⅞
Height:	30½	Usable Seat Depth:	19¾
Seat Depth:	19¾	Ship Weight:	51
Seat Width:	22¼	Cube:	8.9
Back Width:	22¼	Weight Rating:	250 lbs.
Back Height:	17½		

MODEL / DESCRIPTION

HVL887.SB11
Black SofThread™ Leather

LIST PRICE

\$1000

HVL888

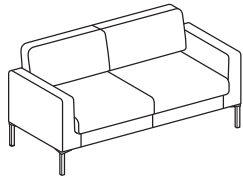

SOFA

DIMENSIONS

Depth:	28	Arm Width:	55
Width:	67	Seat to Floor Height:	17⅞
Height:	30½	Usable Seat Depth:	19¾
Seat Depth:	19¾	Ship Weight:	78
Seat Width:	55	Cube:	18.3
Back Width:	55	Weight Rating:	250 lbs.
Back Height:	17½		

MODEL / DESCRIPTION

HVL888.SB11
Black SofThread™ Leather

LIST PRICE

\$1282



CRIO MESH CHAIRS

HVL581



HIGH-BACK

Pneumatic
Swivel
Tilt
Tilt Tension
Tilt Lock
Height and Width Adjustable Arms
Adjustable Lumbar

DIMENSIONS

Depth:	25½	Arm Width:	19⅞
Width:	28¾	Seat to Floor Height:	16½-20¼
Height:	42⅞	Usable Seat Depth:	17¼
Seat Depth:	17¼	Ship Weight:	39.8 Ⓢ
Seat Width:	20¼	Cube:	4.8
Back Width:	18½	Weight Rating:	250 lbs.

MODEL / DESCRIPTION

HVL581.ES10.T

Black fabric, Black frame

HVL581.SB11.T

Black SofThread™ Leather, Black frame

LIST PRICE

\$379

\$404

HVL582



HIGH-BACK

Pneumatic
Swivel
Tilt
Tilt Tension
Tilt Lock
Asynchronous Control
Seat Glide Mechanism
Adjustable Lumbar
Height and Width Adjustable Arms

DIMENSIONS

Depth:	27½	Arm Width:	19⅞
Width:	28¾	Seat to Floor Height:	20½-22⅞
Height:	43¾	Usable Seat Depth:	17¼
Seat Depth:	17¼	Ship Weight:	50.4 Ⓢ
Seat Width:	19⅞	Cube:	6.8
Back Width:	18½	Weight Rating:	250 lbs.

MODEL / DESCRIPTION

HVL582.ES10.T

Black fabric, Black frame

HVL582.SB11.T

Black SofThread™ Leather, Black frame

LIST PRICE

\$467

\$492

HVL585



EXECUTIVE BIG AND TALL

Pneumatic
Swivel
Tilt
Tilt Tension
Tilt Lock
Height and Width Adjustable Arms
Adjustable Lumbar

DIMENSIONS

Depth:	29⅞	Arm Width:	20½
Width:	28¾	Seat to Floor Height:	17⅞-21¼
Height:	45⅞	Usable Seat Depth:	19⅞
Seat Depth:	19⅞	Ship Weight:	55.4 Ⓢ
Seat Width:	22	Cube:	7.2
Back Width:	20⅞	Weight Rating:	450 lbs.

MODEL / DESCRIPTION

HVL585.ES10.T

Black fabric, Black frame

LIST PRICE

\$658



DEFINE™ EXECUTIVE CHAIRS

HVL108



HIGH-BACK

Pneumatic
Swivel
Synchro-tilt
Height-adjustable Arms

DIMENSIONS

Depth:	29 ³ / ₄	Arm Width:	19 ¹ / ₂
Width:	29 ³ / ₄	Seat to Floor Height:	17 ¹ / ₈ -21 ³ / ₈
Height:	46 ⁷ / ₈	Usable Seat Depth:	17 ¹ / ₂
Seat Depth:	17 ¹ / ₂	Ship Weight:	47.3
Seat Width:	21	Cube:	7.2
Back Width:	20	Weight Rating:	250 lbs.
Back Height:	26 ¹ / ₂		

MODEL / DESCRIPTION

HVL108.SB11
Black SofThread™ Leather

LIST PRICE

\$585

ENTIRE™ MESH CHAIRS

HVL541



HIGH-BACK

Pneumatic
Swivel
Tilt
Tilt Tension
Tilt Lock
Adjustable Lumbar
Height-adjustable Arms

DIMENSIONS

Depth:	28 ³ / ₈	Arm Width:	19 ³ / ₄
Width:	28 ³ / ₈	Seat to Floor Height:	17 ³ / ₄ -22 ¹ / ₂
Height:	43 ³ / ₈	Usable Seat Depth:	19 ¹ / ₄
Seat Depth:	19 ¹ / ₄	Ship Weight:	44.0
Seat Width:	19 ⁵ / ₈	Cube:	4.0
Back Width:	16 ³ / ₄	Weight Rating:	250 lbs.
Back Height:	22 ³ / ₄		

MODEL / DESCRIPTION

HVL541.LH10
Black fabric

LIST PRICE

\$433

EXPOSURE™ MESH CHAIRS

HVL721



HIGH-BACK

Pneumatic
Swivel
Synchronized Tilt
Tilt Tension
Tilt Lock
Seat Glide Mechanism
Adjustable Lumbar
Height and Width Adjustable
Arms

DIMENSIONS

Depth:	26 ³ / ₄	Arm Width:	16 ¹ / ₂ -18 ³ / ₄
Width:	26 ¹ / ₂	Seat to Floor Height:	17 ¹ / ₂ -22
Height:	42 ¹ / ₂	Usable Seat Depth:	17 ¹ / ₂ -19 ¹ / ₂
Seat Depth:	17 ¹ / ₂ -19 ¹ / ₂	Ship Weight:	40.0
Seat Width:	19 ¹ / ₂	Cube:	5.5
Back Width:	18 ¹ / ₂	Weight Rating:	250 lbs.
Back Height:	24 ¹ / ₄		

MODEL / DESCRIPTION

HVL721.LH10
Black fabric

LIST PRICE

\$595



FLOCK® COLLABORATIVE

HFLSC1

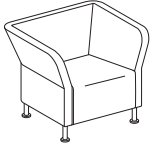

LOUNGE CHAIR

Square

DIMENSIONS

Depth:	28½	Arm Width:	27½
Width:	34¼	Seat to Floor Height:	17
Height:	28	Usable Seat Depth:	20½
Seat Depth:	20½	Ship Weight:	79
Seat Width:	21½	Cube:	21.9
Back Width:	21½	Weight Rating:	300 lbs.
Back Height:	18½		

MODEL / DESCRIPTION

HFLSC1.TS.APX13.PR8

Tapered Square legs, Apex Navy fabric, Textured Silver leg color

LIST PRICE

\$1822

HFLSC1.TS.APX25.PR8

Tapered Square legs, Apex Basalt fabric, Textured Silver leg color

\$1822

HFLSC1.TS.UR10.PR8

Tapered Square legs, Contourett Black upholstery, Textured Silver leg color

\$1822

HFLMC1

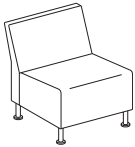

MODULAR CHAIR

DIMENSIONS

Depth:	28½	Seat to Floor Height:	17
Width:	25	Usable Seat Depth:	20½
Height:	28	Ship Weight:	54
Seat Depth:	20½	Cube:	21.9
Seat Width:	25	Weight Rating:	300 lbs.
Back Width:	25		
Back Height:	18½		

MODEL / DESCRIPTION

HFLMC1.TS.APX13.PR8

Tapered Square legs, Apex Navy fabric, Textured Silver leg color

LIST PRICE

\$1335

HFLMC1.TS.APX25.PR8

Tapered Square legs, Apex Basalt fabric, Textured Silver leg color

\$1335

HFLMC1.TS.UR10.PR8

Tapered Square legs, Contourett Black upholstery, Textured Silver leg color

\$1335



FLOCK® MINI CYLINDER

HFLY01

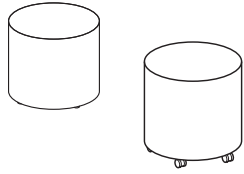

MINI CYLINDER

DIMENSIONS

Depth:	18½	Seat to Floor Height:	17
Width:	18½	Usable Seat Depth:	18½
Height:	17	Ship Weight:	13
Seat Depth:	18½	Cube:	5.0
Seat Width:	18½	Weight Rating:	300 lbs.

MODEL / DESCRIPTION

HFLY01.H.APX13

Casters, Apex Navy fabric

HFLY01.H.APX25

Casters, Apex Basalt fabric

HFLY01.H.UR10

Casters, Contourett Black upholstery

LIST PRICE

\$466

\$466

\$466



GATEWAY™ TASK CHAIRS

HGV1MM

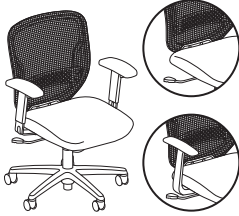

TASK CHAIR VALUE MODEL

- Mesh Back**
- Pneumatic
- Swivel
- Tilt Tension
- Tilt Lock
- Adjustable Lumbar Support

DIMENSIONS

Depth:	25¼	Seat to Floor Height:	17-22
Width:	27	Usable Seat Depth:	19
Height:	38	Ship Weight:	35
Seat Depth:	19	Cube:	3.4
Seat Width:	18½	Weight Rating:	250 lbs.
Back Width:	18		
Back Height:	18½		

MODEL / DESCRIPTION

HGV1MM.Z1.H.H.M.ACCF10.AL.SB.T

Swivel-tilt control, Height-adjustable arms, Hard casters, Mesh back, Black fabric, Adjustable lumbar, Standard base, Black frame

LIST PRICE

\$289

HGV1MM.Z1.N.H.M.ACCF10.AL.SB.T

Swivel-tilt control, Armless, Hard casters, Mesh back, Black fabric, Adjustable lumbar, Standard base, Black frame

\$244



GUESTSTACKER® 4030 SERIES CHAIRS

H4031



STACKING CHAIRS

Textured Copolymer Seat & Back
Ships 4 per Carton
Painted Legs — Black (T) ONLY

DIMENSIONS

Depth:	21½	Seat to Floor Height:	17½
Width:	21	Usable Seat Depth:	17½
Height:	31	Ship Weight:	51
Seat Depth:	19	Cube:	12.9
Seat Width:	18	Weight Rating:	300 lbs.
Back Width:	20		
Back Height:	11		

MODEL / DESCRIPTION

H4031.LA.T

Lava shell, Black frame

H4031.ON.T

Onyx shell, Black frame

LIST PRICE

\$633

SINGLE UNIT

\$158.25

\$633

\$158.25



IGNITION® TASK CHAIRS

HIWM3



MID-BACK

Pneumatic
Back Height Adjustment
Synchro-tilt
Back Angle Adjustment
Tilt Tension
Tilt Lock
Seat Glide

DIMENSIONS

Upholstered Back Width:	18½	Adjustable Arms Width:	17-19½
Upholstered Back Height:	21-24	Seat to Floor Height:	17¼-21¾
Depth:	39	Usable Seat Depth:	15¼-17¼
Width:	27	Ship Weight (upholstered back):	63 Ⓢ
Height:	44	Cube (upholstered back):	11.3
Seat Depth:	17-19	Weight Rating:	300 lbs.
Seat Width:	20		

MODEL / DESCRIPTION

HIWM3.A.H.U.CU10.T.SB

Height and width adjustable arms, Hard casters, Upholstered back, Centurion Black fabric, Black frame, Standard base

LIST PRICE

\$845

HIEH1



EXECUTIVE HIGH-BACK

Pneumatic
Back Height Adjustment
Swivel
Tilt
Tilt Tension
Tilt Lock

DIMENSIONS

Depth:	38½	Arm Width:	20
Width:	27	Seat to Floor Height:	16¾-21¼
Height:	47½	Usable Seat Depth:	17⅞
Seat Depth:	18	Ship Weight:	56
Seat Width:	20	Cube:	16.0
Back Width:	20	Weight Rating:	300 lbs.
Back Height:	24¾-27¾		

MODEL / DESCRIPTION

HIEH1.F.H.U.CU10.T.SB

Fixed arms, Hard casters, Upholstered back, Centurion Black fabric, Black frame, Standard base

HIEH1.F.H.U.SS11.T.SB

Fixed arms, Hard casters, Upholstered back, Black Denver Leather, Black frame, Standard base

LIST PRICE

\$740

\$1040

IGNITION® TASK STOOL

HITS5



TASK STOOL

Pneumatic
Swivel Back Height Adjustment
Adjustable Footrest

DIMENSIONS

Upholstered Back		Seat Depth:	17
Width:	17½	Seat Width:	19
Upholstered Back		Adjustable Arms Width:	17-19½
Height:	18¾-21¾	Seat to Floor Height:	23⅝-33⅝
Depth:	27½	Ship Weight (upholstered back):	56 Ⓢ
Width:	27	Cube (upholstered back):	11.3
Height:	44	Weight Rating:	300 lbs.

MODEL / DESCRIPTION

HITS5.A.H.U.CU10.T.SB

Height and width adjustable arms, Hard casters, Upholstered back, Centurion Black fabric, Black frame, Standard base

LIST PRICE

\$776

IGNITION® 2.0 TASK CHAIRS

HIWMMKD



TASK MID-BACK

4-Way Stretch Mesh Back
 Pneumatic
 Swivel
 Synchro-tilt
 Tilt Tension
 Tilt Lock
 Seat Slide

DIMENSIONS

Depth:	24	Width (with arms):	27
Height:	43¾	Width (armless):	21
Seat Depth:	17¾	Cube:	5.6 ⑨
Seat Width:	20	Weight Rating:	300 lbs.
Back Width:	19		
Back Height:	29		

MODEL / DESCRIPTION

HIWMMKD.Y2.A.H.IF.CU10.AL.SB.T

Advanced synchro-tilt, Height and width adjustable arms, Hard casters, Fog Mesh, Centurion Black fabric, Adjustable lumbar, Standard base, Black frame

LIST PRICE

\$682

HIWMMKD.Y2.A.H.IM.APX13.AL.SB.T

Advanced synchro-tilt, Height and width adjustable arms, Hard casters, Black Mesh, Apex Navy fabric, Adjustable lumbar, Standard base, Black frame

\$682

HIWMMKD.Y2.A.H.IM.APX25.AL.SB.T

Advanced synchro-tilt, Height and width adjustable arms, Hard casters, Black Mesh, Apex Basalt fabric, Adjustable lumbar, Standard base, Black frame

\$682

HIWMMKD.Y2.A.H.IM.CU10.AL.SB.T

Advanced synchro-tilt, Height and width adjustable arms, Hard casters, Black Mesh, Centurion Black fabric, Adjustable lumbar, Standard base, Black frame

\$682

HIWMMKD.Y2.A.H.IM.UR10.AL.SB.T

Advanced synchro-tilt, Height and width adjustable arms, Hard casters, Black Mesh, Contourett Black upholstery, Adjustable lumbar, Standard base, Black frame

\$682

IGNITION® 2.0 TASK STOOLS

HITSM



TASK LOW-BACK STOOL

4-Way Stretch Mesh Back
 Pneumatic
 Swivel
 Synchro-tilt
 Tilt Tension
 Tilt Lock

DIMENSIONS

Depth:	22	Width (with arms):	26
Height:	52½	Width (armless):	20
Seat Depth:	16	Cube:	11.1
Seat Width:	18½	Weight Rating:	300 lbs.
Back Width:	17½		
Back Height:	25½		

MODEL / DESCRIPTION

HITSM.S1.A.H.IM.CU10.AL.SB.T

Limited recline synchro-tilt with seat slider, Height and width adjustable arms, Hard casters, Black Mesh, Centurion Black fabric, Adjustable lumbar, Standard base, Black frame

LIST PRICE

\$728



IGNITION® 2.0 REACTIV® TASK CHAIRS

HIWMRAKD



TASK MID-BACK

ReActiv® Back
Pneumatic
Swivel
Synchro-tilt
Tilt Tension
Tilt Lock
Seat Slide

DIMENSIONS

Depth:	24	Width (with arms):	27
Height:	43¾	Cube:	6.3 Ⓢ
Seat Depth:	17¾	Weight Rating:	300 lbs.
Seat Width:	20		
Back Width:	19		
Back Height:	29		

MODEL / DESCRIPTION

HIWMRAKD.Y2.A.H.OS.CU10.AL.SB.T

Advanced synchro-tilt, Height and width adjustable arms, Hard casters, Charcoal ReActiv® back, Centurion Black fabric, Adjustable lumbar, Standard base, Black frame

LIST PRICE

\$717

IGNITION® 2.0 UPHOLSTERED TASK CHAIRS

HIWMU



TASK MID-BACK

Upholstered Back
Pneumatic
Swivel
Synchro-tilt
Tilt Tension
Tilt Lock
Seat Slide

DIMENSIONS

Depth:	24	Width (with arms):	27
Height:	43¾	Width (armless):	21
Seat Depth:	17¾	Cube:	11.1
Seat Width:	20	Weight Rating:	300 lbs.
Back Width:	19		
Back Height:	23		

MODEL / DESCRIPTION

HIWMU.Y2.F.H.UR10.NL.SB.T

Advanced synchro-tilt, Fixed arms, Hard casters, Contourett Black upholstery, Standard base, Black frame

LIST PRICE

\$682

HIWMUKD



TASK MID-BACK

Upholstered Back
Pneumatic
Swivel
Synchro-tilt
Tilt Tension
Tilt Lock
Seat Slide

DIMENSIONS

Depth:	24	Width (with arms):	27
Height:	43¾	Width (armless):	21
Seat Depth:	17¾	Cube:	5.6 Ⓢ
Seat Width:	20	Weight Rating:	300 lbs.
Back Width:	19		
Back Height:	23		

MODEL / DESCRIPTION

HIWMUKD.Y2.A.H.APX13.NL.SB.T

Advanced synchro-tilt, Height and width adjustable arms, Hard casters, Apex Navy fabric, Standard base, Black frame

LIST PRICE

\$652

HIWMUKD.Y2.A.H.APX25.NL.SB.T

Advanced synchro-tilt, Height and width adjustable arms, Hard casters, Apex Basalt fabric, Standard base, Black frame

\$652

HIWMUKD.Y2.A.H.CU10.NL.SB.T

Advanced synchro-tilt, Height and width adjustable arms, Hard casters, Centurion Black fabric, Standard base, Black frame

\$652

HIWMUKD.Y2.A.H.UR10.NL.SB.T

Advanced synchro-tilt, Height and width adjustable arms, Hard casters, Contourett Black upholstery, Standard base, Black frame

\$652

IGNITION® CHAIRS

HIGS6



MULTI-PURPOSE

Four Legs

DIMENSIONS

Depth:	21 ³ / ₄	Arm Width:	21 ¹ / ₂
Width:	25	Seat to Floor Height:	18 ³ / ₈
Height:	33 ¹ / ₂	Usable Seat Depth:	17 ³ / ₈
Seat Depth:	17 ³ / ₈	Ship Weight:	28
Seat Width:	18 ³ / ₄	Cube:	15.1
Back Width:	18 ¹ / ₄	Weight Rating:	300 lbs.
Back Height:	18 ¹ / ₈		

MODEL / DESCRIPTION

HIGS6.F.A.IM.CU10.T

Fixed arms, All Surface casters, Black Mesh, Centurion Black fabric, Black frame

LIST PRICE

\$471

HIGS6.F.A.U.CU10.T

Fixed arms, All Surface casters, Upholstered back, Centurion Black fabric, Black frame

\$471

HIGS6.F.A.IM.APX13.T

Fixed arms, All Surface casters, Black Mesh, Apex Navy fabric, Black frame

\$471

HIGS6.F.A.IM.APX25.T

Fixed arms, All Surface casters, Black Mesh, Apex Basalt fabric, Black frame

\$471

IGNITION® STOOLS

HICS7

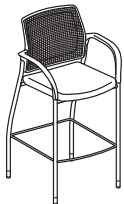

CAFÉ-HEIGHT STOOL

Four Legs

DIMENSIONS

Depth:	23	Arm Width:	21 ¹ / ₂
Width:	25	Seat to Floor Height:	31
Height:	46 ¹ / ₂	Usable Seat Depth:	17 ³ / ₈
Seat Depth:	17 ³ / ₈	Ship Weight:	37
Seat Width:	18 ³ / ₄	Cube:	21.8
Back Width:	18 ¹ / ₄	Weight Rating:	300 lbs.
Back Height:	18 ¹ / ₈		

MODEL / DESCRIPTION

HICS7.F.E.IM.CU10.T

Fixed arms, Glides, Black Mesh, Centurion Black fabric, Black frame

LIST PRICE

\$587



INSTIGATE™ MESH GUEST CHAIRS

HVL518



GUEST CHAIR

Leg Base
Arms
Stacks up to Four High

DIMENSIONS

Depth:	22¾	Arm Width:	20¼
Width:	24	Seat to Floor Height:	17¾
Height:	35¾	Usable Seat Depth:	17½
Seat Depth:	17½	Ship Weight:	22.2 Ⓢ
Seat Width:	18½	Cube:	3.2
Back Width:	17½	Weight Rating:	250 lbs.
Back Height:	19		

MODEL / DESCRIPTION

HVL518.ES10
Black fabric

LIST PRICE

\$253

LOTA® CHAIRS

H2285



MULTI-PURPOSE CHAIR

Mesh Back
4-Leg Stacking Frame
Fixed Arms

DIMENSIONS

Depth:	24¾	Arm Width:	19⅞
Width:	23	Seat to Floor Height:	19⅞
Height:	34½	Usable Seat Depth:	17¾
Seat Depth:	17¾	Ship Weight:	20.0 Ⓢ
Seat Width:	18⅞	Cube:	2.8
Back Width:	17⅞	Weight Rating:	250 lbs.
Back Height:	17¾		

NOTES: Ships with casters and glides.

MODEL / DESCRIPTION

H2285.VA10.T
Black fabric, Black frame, Black Mesh

LIST PRICE

\$395

MATTER™ CHAIRS

HVL232



GRAY UPHOLSTERED CHAIR

5-Star Base
Swivel
Tilt

DIMENSIONS

Depth:	24¼	Arm Width:	3
Width:	23	Seat to Floor Height:	19
Height:	34	Usable Seat Depth:	18
Seat Depth:	18⅞	Ship Weight:	21.0 Ⓢ
Seat Width:	16½	Cube:	5.6
Back Width:	23	Weight Rating:	250 lbs.
Back Height:	12¾		

NOTES: **HON 5-Year Limited Warranty**

MODEL / DESCRIPTION

HVL232.GRY01
Light Gray fabric, Chrome base

LIST PRICE

\$475

MATTER™ CHAIRS

HVL238



GRAY UPHOLSTERED CHAIR

Wood Leg Base
Harvest Wood Legs

DIMENSIONS

Depth:	24 $\frac{1}{2}$	Arm Width:	3
Width:	23	Seat to Floor Height:	19
Height:	34	Usable Seat Depth:	18
Seat Depth:	18 $\frac{3}{8}$	Ship Weight:	21.0
Seat Width:	16 $\frac{1}{2}$	Cube:	5.6
Back Width:	23	Weight Rating:	250 lbs.
Back Height:	12 $\frac{1}{2}$		

NOTES: HON 5-Year Limited Warranty

LIST PRICE

\$438

MODEL / DESCRIPTION

HVL238.GRY01

Light Gray fabric, Harvest Wood Leg base



OPEN MARKET

MOTIVATE® HIGH-DENSITY SLED BASE CHAIRS

HMS1



HIGH-DENSITY STACKER

Sled Leg Base
Ships 4 per Carton

DIMENSIONS

Depth:	23	Arm Width:	18 $\frac{1}{8}$
Width:	21	Seat to Floor Height:	17 $\frac{3}{4}$
Height:	32 $\frac{1}{4}$	Usable Seat Depth:	18 $\frac{1}{4}$
Seat Depth:	18 $\frac{1}{4}$	Ship Weight:	72
Seat Width:	17 $\frac{3}{4}$	Cube:	15.2
Back Width:	17 $\frac{1}{4}$	Weight Rating:	300 lbs.
Back Height:	18		

MODEL / DESCRIPTION

HMS1.N.ON.Y

Armless, Onyx shell, Chrome frame

LIST PRICE

\$860

SINGLE UNIT

\$215



SIN 33721

MOTIVATE® NESTING/STACKING FLEX-BACK CHAIRS

HMN2



CHAIR

Flex-back
Nesting/Stacking
Four Legs
Upholstered Seat

DIMENSIONS

Depth:	23 $\frac{1}{8}$	Seat to Floor Height:	19 $\frac{1}{4}$
Width:	26 $\frac{3}{4}$	Usable Seat Depth:	17
Height:	34	Ship Weight (upholstered back):	29
Seat Depth:	17	Ship Weight (plastic/mesh back):	28
Seat Width:	17 $\frac{3}{8}$	Cube (upholstered back):	15.1
Back Width:	19 $\frac{1}{2}$	Cube (plastic/mesh back):	15.1
Back Height:	18 $\frac{3}{8}$	Weight Rating:	300 lbs.
Arm Width:	24		

MODEL / DESCRIPTION

HMN2.F.S.IM.ON.CU10.BLCK

Fixed arms, Soft casters, Black Mesh, Onyx shell, Centurion Black fabric, Textured Black frame

LIST PRICE

\$683

HMN2.F.S.IM.ON.CU10.PLAT

Fixed arms, Soft casters, Black Mesh, Onyx shell, Centurion Black fabric, Textured Platinum Metallic frame

\$683



SIN 33721

NETWORK™

HVL281



LOW-BACK TASK CHAIR

Upholstered
Swivel-tilt
Armless

DIMENSIONS

Depth:	25½	Back Width:	17¾
Width:	25½	Back Height:	17¾
Height:	37½	Seat to Floor Height:	17-21½
Seat Depth:	16½	Ship Weight:	27.9
Seat Width:	18⅝	Cube:	4.3
		Weight Rating:	250 lbs.

MODEL / DESCRIPTION

HVL281.Z1.VA10.T
Swivel tilt, Black fabric, Black frame

LIST PRICE
\$271

HVL282



MID-BACK TASK CHAIR

Upholstered
Swivel-tilt
Height and Width Adjustable
Arms
Height Adjustable Back

DIMENSIONS

Depth:	25¼	Arm Width:	18½
Width:	26½	Seat to Floor Height:	18¾-22¾
Height:	43¾	Ship Weight:	47.0
Seat Depth:	16¾	Cube:	6.0
Seat Width:	19⅞	Weight Rating:	250 lbs.
Back Width:	19⅞		
Back Height:	20½		

MODEL / DESCRIPTION

HVL282.A2.VA10.T
Asynchronous with seat slide, Black fabric, Black frame

HVL282.Z1.VA10.T
Swivel tilt, Black fabric, Black frame

LIST PRICE
\$455

\$400

HVL283



HIGH-BACK TASK CHAIR

Upholstered
Asynchronous with Seat Slide
Height and Width Adjustable
Arms

DIMENSIONS

Depth:	25¼	Arm Width:	17¾
Width:	26½	Seat to Floor Height:	18¾-22¾
Height:	47¼	Ship Weight:	53.3
Seat Depth:	17⅞	Cube:	6.9
Seat Width:	19⅞	Weight Rating:	250 lbs.
Back Width:	20⅞		
Back Height:	23⅞		

MODEL / DESCRIPTION

HVL283.A2.VA10.T
Asynchronous with seat slide, Black fabric, Black frame

LIST PRICE
\$559

HVL289



ADJUSTABLE ARM PACK

Height and Width
Available in Black (T)

DIMENSIONS

Adjustable Arm Width:	18¼
Height from Seat:	7⅞-10⅝
Ship Weight:	9.8
Cube:	0.8

MODEL / DESCRIPTION

HVL289.T
Black frame

LIST PRICE
\$84

PILLOW-SOFT® 2090 SERIES CHAIRS

H2095



EXECUTIVE HIGH-BACK

Pneumatic
Swivel
Tilt
Tilt Tension
Tilt Lock
Padded Loop Arms

DIMENSIONS

Depth:	29½	Arm Width:	21
Width:	26¾	Seat to Floor Height:	16-21
Height:	47½	Usable Seat Depth:	17½
Seat Depth:	17½	Ship Weight:	57 
Seat Width:	21	Cube:	7.1
Back Width:	21	Weight Rating:	275 lbs.
Back Height:	29½		

MODEL / DESCRIPTION

H2095.H.PWST11.T

Hard casters, Black SofThread™ Leather, Black frame

LIST PRICE

\$542



PROMINENT™ MESH CHAIRS

HVL531



HIGH-BACK

Pneumatic
Swivel
Tilt
Tilt Tension
Tilt Lock
Height-adjustable Arms

DIMENSIONS

Depth:	27	Arm Width:	20¼
Width:	27	Seat to Floor Height:	18-22
Height:	42½	Usable Seat Depth:	18
Seat Depth:	18	Ship Weight:	36
Seat Width:	21½	Cube:	5.1
Back Width:	18¾	Weight Rating:	250 lbs.
Back Height:	23		

MODEL / DESCRIPTION

HVL531.MM10
Black Sandwich Mesh fabric
HVL531.SB11
Black SofThread™ Leather

LIST PRICE

\$418
\$443

HVL532



HIGH-BACK

Mesh Back
Pneumatic
Swivel
Asynchronous Control
Tilt
Tilt Tension
Tilt Lock
Seat Glide Mechanism
Back Height Adjustment
Height and Width Adjustable
Arms

DIMENSIONS

Depth:	26	Arm Width:	18-22½
Width:	30¾	Seat to Floor Height:	17-20½
Height:	44½	Ship Weight:	50
Seat Depth:	17⅞-20⅞	Cube:	6.5
Seat Width:	20½	Weight Rating:	250 lbs.
Back Width:	19⅞		
Back Height:	23¼-24½		

MODEL / DESCRIPTION

HVL532.MM10
Black Sandwich Mesh fabric
HVL532.SB11
Black SofThread™ Leather

LIST PRICE

\$498
\$523



PROMINENT™ MESH CHAIRS

HVL534



HIGH-BACK

Pneumatic
Swivel
Tilt
Tilt Tension
Tilt Lock
Height-adjustable Arms

DIMENSIONS

Depth:	27	Arm Width:	19 ⁵ / ₈
Width:	27	Seat to Floor Height:	17 ¹ / ₈ -20 ³ / ₄
Height:	41 ¹ / ₈	Usable Seat Depth:	19 ¹ / ₈
Seat Depth:	19 ¹ / ₈	Ship Weight:	40.6
Seat Width:	20 ¹ / ₈	Cube:	5.7
Back Width:	19 ¹ / ₈	Weight Rating:	250 lbs.
Back Height:	22 ³ / ₈		

MODEL / DESCRIPTION

HVL534.MST3
Black Mesh

LIST PRICE

\$513

HVL539



TASK STOOL

Mesh Back
Pneumatic
Swivel
Height and Width Adjustable
Arms
Adjustable Footring

DIMENSIONS

Depth:	27 ⁹ / ₁₆	Arm Width:	18 ¹ / ₈
Width:	28 ¹⁷ / ₃₂	Seat to Floor Height:	21 ⁹ / ₃₂ -28 ⁵ / ₃₂
Height:	50	Usable Seat Depth:	17 ¹ / ₈
Seat Depth:	17 ¹ / ₈	Ship Weight:	44.0
Seat Width:	20 ¹⁵ / ₃₂	Cube:	5.7
Back Width:	17 ¹ / ₈	Weight Rating:	250 lbs.
Back Height:	22 ²⁷ / ₃₂		

MODEL / DESCRIPTION

HVL539.MM10
Black Sandwich Mesh fabric

LIST PRICE

\$457



RUCK™ LAMINATE SEATING

HRUCK1L



CHAIR, LAMINATE SHELL

DIMENSIONS

Depth:	22 ⁵ / ₈	Seat to Floor Height:	17 ³ / ₄
Width:	21 ⁵ / ₈	Usable Seat Depth:	18 ¹ / ₄
Height:	32 ⁵ / ₁₆	Ship Weight:	24
Seat Depth:	18 ³ / ₄	Cube:	15.8
Seat Width:	17 ¹ / ₂	Weight Rating:	300 lbs.
Back Width:	17		
Back Height:	15 ⁵ / ₈		

MODEL / DESCRIPTION

HRUCK1L.PINC.PR8

Pinnacle laminate, Silver legs

HRUCK1L.LDW1.PR8

Designer White laminate, Silver legs

HRUCK1L.S.PR8

Charcoal laminate, Silver legs

LIST PRICE

\$500

\$500

\$500

HRUCK5L



STOOL, LAMINATE SHELL

DIMENSIONS

Depth:	22 ⁵ / ₈	Seat to Floor Height:	30
Width:	21 ⁵ / ₈	Usable Seat Depth:	18 ¹ / ₄
Height:	44 ¹ / ₂	Ship Weight:	32
Seat Depth:	18 ³ / ₄	Cube:	22.2
Seat Width:	17 ¹ / ₂	Weight Rating:	300 lbs.
Back Width:	17		
Back Height:	15 ⁵ / ₈		

MODEL / DESCRIPTION

HRUCK5L.PINC.PR8

Pinnacle laminate, Silver legs

HRUCK5L.LDW1.PR8

Designer White laminate, Silver legs

HRUCK5L.S.PR8

Charcoal laminate, Silver legs

LIST PRICE

\$600

\$600

\$600

SCATTER™ GUEST CHAIRS

HVL606



GUEST CHAIR

Leg Base
Armless
Stacks up to Four High

DIMENSIONS

Depth:	21	Seat to Floor Height:	19
Width:	21¼	Usable Seat Depth:	17½
Height:	32¾	Ship Weight:	16
Seat Depth:	17½	Cube:	2.1
Seat Width:	19	Weight Rating:	250 lbs.
Back Width:	18½		
Back Height:	16		

NOTES: Ships with glides and casters.

MODEL / DESCRIPTION

HVL606.SB11
Black SofThread™ Leather

HVL606.VA10
Black fabric

HVL606.VA90
Navy fabric

LIST PRICE

\$187

\$157

\$157



OPEN MARKET

HVL616



GUEST CHAIR

Leg Base
Arms
Stacks up to Four High

DIMENSIONS

Depth:	21	Arm Width:	20¼
Width:	23¼	Seat to Floor Height:	19
Height:	32¾	Usable Seat Depth:	17½
Seat Depth:	17½	Ship Weight:	18
Seat Width:	19	Cube:	2.1
Back Width:	18½	Weight Rating:	250 lbs.
Back Height:	16		

NOTES: Ships with glides and casters.

MODEL / DESCRIPTION

HVL616.SB11
Black SofThread™ Leather

HVL616.VA10
Black fabric

LIST PRICE

\$207

\$177



OPEN MARKET

SOLUTIONS GUEST CHAIRS

H4008



GUEST CHAIR

Sled Base
Arms

DIMENSIONS

Depth:	25½	Arm Width:	19
Width:	23½	Seat to Floor Height:	19¼
Height:	32½	Usable Seat Depth:	18¼
Seat Depth:	18	Ship Weight:	33
Seat Width:	20	Cube:	12.6
Back Width:	21	Weight Rating:	250 lbs.
Back Height:	15		

MODEL / DESCRIPTION

H4008.CU10.T
Centurion Black fabric, Black frame

LIST PRICE

\$373



SIN 33721



SOLVE® TASK CHAIRS

HSLVTMMKD



MID-BACK TASK

4-Way Stretch Back
Pneumatic
Swivel
Synchro-tilt
Tilt Tension
Tilt Lock

DIMENSIONS

Seat Depth:	19¼	Arm Width:	17½-20
Seat Width:	19	Cube:	7.6 ③
Back Width:	18¼	Weight Rating:	300 lbs.
Back Height:	22⅝		

MODEL / DESCRIPTION

HSLVTMMKD.Y1.A.H.IM.APX13.BL.SB.T

Synchro-tilt with seat slider, Height and width adjustable arms, Hard casters, Black Mesh, Apex Navy fabric, Black adjustable lumbar, Standard base, Black frame

LIST PRICE

\$562

HSLVTMMKD.Y1.A.H.IM.APX25.BL.SB.T

Synchro-tilt with seat slider, Height and width adjustable arms, Hard casters, Black Mesh, Apex Basalt fabric, Black adjustable lumbar, Standard base, Black frame

\$562

HSLVTMMKD.Y1.A.H.IM.CU10.BL.SB.T

Synchro-tilt with seat slider, Height and width adjustable arms, Hard casters, Black Mesh, Centurion Black fabric, Black adjustable lumbar, Standard base, Black frame

\$562

HSLVTMMKD.Y1.A.H.IM.UR10.BL.SB.T

Synchro-tilt with seat slider, Height and width adjustable arms, Hard casters, Black Mesh, Contourett Black upholstery, Black adjustable lumbar, Standard base, Black frame

\$562

HSLVTMR

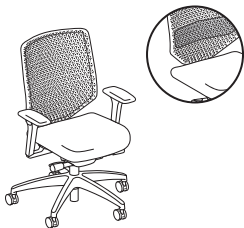

MID-BACK TASK

ReActiv® Back
Pneumatic
Swivel
Synchro-tilt
Tilt Tension
Tilt Lock

DIMENSIONS

Seat Depth:	19¼	Arm Width:	17½-20
Seat Width:	19	Cube:	10.8
Back Width:	18¼	Weight Rating:	300 lbs.
Back Height:	21½		

MODEL / DESCRIPTION

HSLVTMR.Y1.A.H.TI.UR10.NL.SB.TI

Synchro-tilt with seat slider, Height and width adjustable arms, Hard casters, Titanium ReActiv® back, Contourett Black upholstery, Standard base, Titanium frame

LIST PRICE

\$642

SOLVE® STOOLS

HSLVSMM



STOOL

4-Way Stretch Back
Pneumatic
Swivel
Synchro-tilt
Tilt Tension
Tilt Lock

DIMENSIONS

Seat Depth:	19¼	Arm Width:	17½-20
Seat Width:	19	Cube:	7.6
Back Width:	18¼	Weight Rating:	300 lbs.
Back Height:	22⅝		

MODEL / DESCRIPTION

HSLVSMM.Y1.A.H.IM.CU10.BL.SB.T

Synchro-tilt with seat slider, Height and width adjustable arms, Hard casters, Black Mesh, Centurion Black fabric, Black adjustable lumbar, Standard base, Black frame

LIST PRICE

\$659



TORCH™ MESH CHAIRS

HVL511



MID-BACK

Pneumatic
Swivel
Tilt
Tilt Tension
Tilt Lock
Fixed Arms

DIMENSIONS

Depth:	26	Arm Width:	18 ³ / ₄
Width:	26	Seat to Floor Height:	16 ¹ / ₈ -20 ⁵ / ₈
Height:	40 ¹ / ₂	Usable Seat Depth:	18 ¹ / ₄
Seat Depth:	18 ¹ / ₄	Ship Weight:	30
Seat Width:	19 ¹ / ₂	Cube:	3.8
Back Width:	17 ³ / ₄	Weight Rating:	250 lbs.
Back Height:	21 ³ / ₄		

MODEL / DESCRIPTION

HVL511.LH10
Black fabric

LIST PRICE

\$295

HVL515

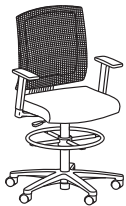

TASK STOOL

Pneumatic
Swivel
Fixed Arms

DIMENSIONS

Depth:	26	Arm Width:	18 ³ / ₄
Width:	26	Seat to Floor Height:	23 ¹ / ₈ -33
Height:	52	Usable Seat Depth:	18 ¹ / ₄
Seat Depth:	18 ¹ / ₄	Ship Weight:	38
Seat Width:	19 ¹ / ₂	Cube:	4.6
Back Width:	17 ³ / ₄	Weight Rating:	250 lbs.
Back Height:	21 ³ / ₄		

MODEL / DESCRIPTION

HVL515.LH10
Black fabric

LIST PRICE

\$412



TRACTION™ EXECUTIVE CHAIRS

HVL103



HIGH-BACK

Pneumatic
Swivel
Tilt
Tilt Tension
Tilt Lock
Fixed Padded Arms

DIMENSIONS

Depth:	28 ³ / ₄	Arm Width:	18 ⁷ / ₈
Width:	26 ³ / ₄	Seat to Floor Height:	17 ¹ / ₄ -21
Height:	42 ¹ / ₂	Usable Seat Depth:	18 ¹ / ₄
Seat Depth:	18 ¹ / ₄	Ship Weight:	36.0
Seat Width:	19 ¹ / ₂	Cube:	4.1
Back Width:	19 ¹ / ₂	Weight Rating:	250 lbs.
Back Height:	24 ⁷ / ₈		

MODEL / DESCRIPTION

HVL103.SB11
Black SofThread™ Leather

LIST PRICE

\$455

HVL102



HIGH-BACK MODERN GUEST CHAIR

Padded Arms
Cantilever Base

DIMENSIONS

Depth:	27 ¹¹ / ₆₄	Arm Width:	18 ⁴⁵ / ₆₄
Width:	20 ⁵ / ₆₄	Seat to Floor Height:	18 ²⁹ / ₃₂
Height:	39 ³ / ₈	Usable Seat Depth:	18 ⁷ / ₆₄
Seat Depth:	18 ⁷ / ₆₄	Ship Weight:	36.8
Seat Width:	19 ¹¹ / ₁₆	Cube:	4.4
Back Width:	18 ²⁹ / ₃₂	Weight Rating:	250 lbs.
Back Height:	24 ³⁹ / ₆₄		

MODEL / DESCRIPTION

HVL102.SB11
Black SofThread™ Leather

LIST PRICE

\$343



VALIDATE™ GUEST CHAIRS

HVL605



GUEST CHAIR

Leg Base
Arms
Stacks up to Four High

DIMENSIONS

Depth:	24	Arm Width:	19½
Width:	23½	Seat to Floor Height:	18½
Height:	34½	Usable Seat Depth:	17½
Seat Depth:	17½	Ship Weight:	22.2
Seat Width:	18½	Cube:	3.0
Back Width:	18½	Weight Rating:	250 lbs.
Back Height:	17¾		

MODEL / DESCRIPTION

HVL605.SB11
Black SofThread™ Leather

LIST PRICE

\$280



VALUTASK®

HVL210



TASK LOW-BACK

Pneumatic
Swivel
Tilt
Tilt Tension
Tilt Lock

DIMENSIONS

Depth:	33½	Seat to Floor Height:	17-20½
Width:	24½	Usable Seat Depth:	17¾
Height:	38¾	Ship Weight:	31 Ⓢ
Seat Depth:	17¾	Cube:	3.6
Seat Width:	19¾	Weight Rating:	250 lbs.
Back Width:	19¾		
Back Height:	20¼		

MODEL / DESCRIPTION

HVL210.MM10

Black Sandwich Mesh fabric

LIST PRICE

\$242

HVL215



TASK STOOL

Pneumatic
Swivel

DIMENSIONS

Depth:	33½	Seat to Floor Height:	24½-33½
Width:	24½	Usable Seat Depth:	17¾
Height:	51⅞	Ship Weight:	37 Ⓢ
Seat Depth:	17¾	Cube:	5.7
Seat Width:	19¾	Weight Rating:	250 lbs.
Back Width:	19¾		
Back Height:	19		

MODEL / DESCRIPTION

HVL215.MM10

Black Sandwich Mesh fabric

LIST PRICE

\$337

HVL995



HEIGHT-ADJUSTABLE ARMS

DIMENSIONS

Adjustable Arms Width:	18¾
Height from Seat:	8-11
Ship Weight:	7 Ⓢ
Cube:	0.6

MODEL / DESCRIPTION

HVL995

Black frame

LIST PRICE

\$100

VOLT® 5700 SERIES

H5701



TASK CHAIR

Pneumatic
Swivel
Tilt
Tilt Tension
Tilt Lock

DIMENSIONS

Depth:	25 ³ / ₄	Seat to Floor Height:	18-22 ¹ / ₄
Width:	26	Usable Seat Depth:	18 ³ / ₄
Height:	40	Ship Weight:	29
Seat Depth:	18 ³ / ₄	Cube:	5.1
Seat Width:	18 ¹ / ₂	Weight Rating:	250 lbs.
Back Width:	17 ¹ / ₄		
Back Height:	18 ³ / ₄		

MODEL / DESCRIPTION

H5701.GA10.T

Black fabric, Black frame

H5701.SB11.T

Black leather, Black frame

LIST PRICE

\$295

\$325



H5703



TASK CHAIR

Pneumatic
Swivel
Synchro-tilt
Tilt Tension
Tilt Lock

DIMENSIONS

Depth:	25 ³ / ₄	Seat to Floor Height:	18-22 ¹ / ₄
Width:	26	Usable Seat Depth:	18 ³ / ₄
Height:	40	Ship Weight:	29
Seat Depth:	18 ³ / ₄	Cube:	5.1
Seat Width:	18 ¹ / ₂	Weight Rating:	250 lbs.
Back Width:	17 ¹ / ₄		
Back Height:	18 ³ / ₄		

MODEL / DESCRIPTION

H5703.SB11.T

Black leather, Black frame

LIST PRICE

\$373



H5705



TASK STOOL

Pneumatic
Swivel
Adjustable Footring

DIMENSIONS

Depth:	29 ¹ / ₂	Seat to Floor Height:	22 ⁷ / ₈ -32 ³ / ₈
Width:	27	Usable Seat Depth:	18
Height:	49 ⁷ / ₈	Ship Weight:	36
Seat Depth:	20	Cube:	6.0
Seat Width:	19	Weight Rating:	250 lbs.
Back Width:	16 ¹ / ₂		
Back Height:	20		

MODEL / DESCRIPTION

H5705.GA10.T

Black fabric, Black frame

LIST PRICE

\$484



H5795

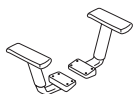

HEIGHT-ADJUSTABLE ARMS

Non-upholstered

DIMENSIONS

Adjustable Arms Width:	17 ³ / ₈
Height from Seat:	7 ⁷ / ₈ -10 ⁵ / ₈
Ship Weight:	5
Cube:	0.6

MODEL / DESCRIPTION

H5795.T

Black frame

LIST PRICE

\$92



VOLT® 5710 SERIES

H5711



TASK CHAIR

Mesh Back
Pneumatic
Swivel
Tilt
Tilt Tension
Tilt Lock

DIMENSIONS

Depth:	25¾	Seat to Floor Height:	18¼-22¾
Width:	26	Usable Seat Depth:	18
Height:	38¾	Ship Weight:	29
Seat Depth:	18¾	Cube:	4.8
Seat Width:	19¼	Weight Rating:	250 lbs.
Back Width:	18		
Back Height:	18¾		

MODEL / DESCRIPTION

H5711.GA10.T

Black fabric, Black frame

LIST PRICE

\$408

H5711.SB11.T

Black leather, Black frame

\$438



H5715



TASK STOOL

Mesh Back
Pneumatic
Swivel
Adjustable Footring

DIMENSIONS

Depth:	28	Seat to Floor Height:	22⅞-32⅜
Width:	26	Usable Seat Depth:	18
Height:	49⅞	Ship Weight:	36
Seat Depth:	20	Cube:	5.6
Seat Width:	19	Weight Rating:	250 lbs.
Back Width:	18		
Back Height:	18½		

MODEL / DESCRIPTION

H5715.GA10.T

Black fabric, Black frame

LIST PRICE

\$603

H5715.SB11.T

Black leather, Black frame

\$633





WAVE™ MESH CHAIRS

HVL701



HIGH-BACK

Pneumatic
Swivel
Knee Tilt
Tilt Tension
Infinite Tilt Lock
Adjustable Lumbar
Height-adjustable Arms

DIMENSIONS

Depth:	28	Arm Width:	19½
Width:	27½	Seat to Floor Height:	18½-21¼
Height:	44⅝	Usable Seat Depth:	19¼
Seat Depth:	20¾	Ship Weight:	53 Ⓢ
Seat Width:	22	Cube:	5.8
Back Width:	23	Weight Rating:	250 lbs.
Back Height:	23¾		

MODEL / DESCRIPTION

HVL701.SB11

Black SofThread™ Leather

LIST PRICE

\$812

SIN 33721

HVL702



HIGH-BACK

Pneumatic
Swivel
Synchro-tilt
Tilt Tension
Tilt Lock
Height-adjustable Arms

DIMENSIONS

Depth:	26½	Arm Width:	19½
Width:	26½	Seat to Floor Height:	18½-23½
Height:	40½	Usable Seat Depth:	19¾
Seat Depth:	19¾	Ship Weight:	40 Ⓢ
Seat Width:	21	Cube:	5.0
Back Width:	19½	Weight Rating:	250 lbs.
Back Height:	24		

MODEL / DESCRIPTION

HVL702.MM10

Black Sandwich Mesh fabric

LIST PRICE

\$658

OPEN MARKET

HVL705



EXECUTIVE BIG AND TALL

Pneumatic
Knee Tilt
Tilt Tension
Tilt Lock
Height and Width Adjustable Arms
Integrated Lumbar Support

DIMENSIONS

Depth:	25⅝	Seat to Floor Height:	19¼-22¼
Width:	30¼	Usable Seat Depth:	18¾
Height:	42⅞	Ship Weight:	59 Ⓢ
Seat Depth:	18¾	Cube:	6.1
Seat Width:	21⅝	Weight Rating:	450 lbs.
Back Width:	22¾		
Back Height:	28		

MODEL / DESCRIPTION

HVL705.VM10

Black Mesh fabric

LIST PRICE

\$969

OPEN MARKET

HVL712



MID-BACK

Pneumatic
Swivel
Synchro-tilt
Tilt Tension
Tilt Lock
Height-adjustable Arms

DIMENSIONS

Depth:	28½	Arm Width:	18⅞
Width:	29½	Seat to Floor Height:	18-22¼
Height:	41¾	Usable Seat Depth:	18
Seat Depth:	18½	Ship Weight:	39 Ⓢ
Seat Width:	19¾	Cube:	5.4
Back Width:	20½	Weight Rating:	250 lbs.
Back Height:	20¾		

MODEL / DESCRIPTION

HVL712.MM10

Black Sandwich Mesh fabric

LIST PRICE

\$555

SIN 33721



EXECUTIVE CHAIRS

HVL105



HIGH-BACK

Pneumatic
Swivel
Tilt
Tilt Tension
Tilt Lock
Fixed Padded Arms

DIMENSIONS

Depth:	27½	Arm Width:	19
Width:	25	Seat to Floor Height:	17½-20¼
Height:	45¾	Usable Seat Depth:	20¼
Seat Depth:	20¼	Ship Weight:	46 Ⓢ
Seat Width:	19½	Cube:	6.6
Back Width:	20½	Weight Rating:	250 lbs.
Back Height:	28¾		

MODEL / DESCRIPTION

HVL105.SB11
Black SofThread™ Leather

LIST PRICE

\$529

HVL151



HIGH-BACK

Pneumatic
Swivel
Tilt
Tilt Tension
Tilt Lock
Fixed Padded Loop Arms

DIMENSIONS

Depth:	37½	Arm Width:	20½
Width:	27	Seat to Floor Height:	17¾-21½
Height:	45½	Usable Seat Depth:	18⅝
Seat Depth:	18⅝	Ship Weight:	38 Ⓢ
Seat Width:	20½	Cube:	5.1
Back Width:	20½	Weight Rating:	250 lbs.
Back Height:	27¼		

MODEL / DESCRIPTION

HVL151.SB11
Black SofThread™ Leather

LIST PRICE

\$400



EXECUTIVE CHAIRS

HVL601



HIGH-BACK

Pneumatic
Swivel
Tilt
Tilt Tension
Tilt Lock
Loop Arms

DIMENSIONS

Depth:	27	Arm Width:	20½
Width:	26½	Seat to Floor Height:	16¾-20½
Height:	44	Usable Seat Depth:	17
Seat Depth:	17	Ship Weight:	38 Ⓢ
Seat Width:	20½	Cube:	4.1
Back Width:	20½	Weight Rating:	250 lbs.
Back Height:	26½		

MODEL / DESCRIPTION

HVL601.SB11
Black SofThread™ Leather

HVL601.VA10
Black fabric

LIST PRICE

\$324

\$294

GUEST CHAIRS

HVL653



GUEST CHAIR

Sled Base
Padded Arms

DIMENSIONS

Depth:	23	Arm Width:	17¾
Width:	22¼	Seat to Floor Height:	17⅝
Height:	32	Usable Seat Depth:	16¾
Seat Depth:	17	Ship Weight:	28 Ⓢ
Seat Width:	20¼	Cube:	3.1
Back Width:	18½	Weight Rating:	250 lbs.
Back Height:	12		

MODEL / DESCRIPTION

HVL653.SB11
Black SofThread™ Leather

LIST PRICE

\$258

MESH CHAIRS

HVL521



MID-BACK

Pneumatic
Swivel
Tilt
Tilt Tension
Tilt Lock
Arms

DIMENSIONS

Depth:	35¼	Arm Width:	18½
Width:	26¼	Seat to Floor Height:	17½-22
Height:	41	Usable Seat Depth:	17¾
Seat Depth:	17¾	Ship Weight:	30 Ⓢ
Seat Width:	19½	Cube:	4.1
Back Width:	18¾	Weight Rating:	250 lbs.
Back Height:	21½		

MODEL / DESCRIPTION

HVL521.VA10
Black fabric

LIST PRICE

\$348



NESTING CHAIRS

HVL303



SANDWICH MESH BACK AND SEAT

Upholstered Seat and Back
Casters
Arms

DIMENSIONS

Depth:	23¾	Seat to Floor Height:	19¼
Width:	23¾	Usable Seat Depth:	18½
Height:	33½	Ship Weight:	27
Seat Depth:	18½	Cube:	2.1
Seat Width:	19½	Weight Rating:	250 lbs.
Back Width:	19½		
Back Height:	16		

MODEL / DESCRIPTION

HVL303.MM10.T

Black Sandwich Mesh fabric, Black frame

HVL303.MM10.X

Black Sandwich Mesh fabric, Black frame

LIST PRICE

\$314

\$314

NOW Seating

TASK CHAIRS

1-Oh-One



LOW-BACK

Pneumatic
Swivel
Tilt
Tilt Tension
Tilt Lock

DIMENSIONS

Depth:	24 ³ / ₈	Seat to Floor Height:	17-22
Width:	24 ¹ / ₄	Usable Seat Depth:	18
Height:	38 ¹ / ₄	Ship Weight:	25.0
Seat Depth:	18	Cube:	3.0
Seat Width:	18	Weight Rating:	225 lbs.
Back Width:	15		
Back Height:	18		

MODEL / DESCRIPTION

HVST101

Mesh back, Black upholstery, Black frame

LIST PRICE

\$180

1-Oh-Two



LOW-BACK

Pneumatic
Swivel
Tilt
Tilt Tension
Tilt Lock
Fixed Arms

DIMENSIONS

Depth:	24 ³ / ₈	Arm Width:	17 ¹ / ₄
Width:	24 ¹ / ₄	Seat to Floor Height:	17-22
Height:	38 ¹ / ₄	Usable Seat Depth:	18
Seat Depth:	18	Ship Weight:	28.0
Seat Width:	18	Cube:	3.0
Back Width:	15	Weight Rating:	225 lbs.
Back Height:	18		

MODEL / DESCRIPTION

HVST102

Mesh back, Black upholstery, Black frame, Fixed arms

LIST PRICE

\$197

TASK CHAIRS

1-Twenty-One



MID-BACK

Pneumatic
Swivel
Multifunction Control
Tilt
Tilt Tension
Tilt Lock
Back Height Adjustment
Height-adjustable Arms

DIMENSIONS

Depth:	25	Arm Width:	19 ³ / ₄
Width:	25 ³ / ₄	Seat to Floor Height:	16-19
Height:	44 ¹ / ₂	Usable Seat Depth:	18
Seat Depth:	18	Ship Weight:	40 Ⓢ
Seat Width:	20	Cube:	5.6
Back Width:	17	Weight Rating:	225 lbs.
Back Height:	24-25		

MODEL / DESCRIPTION

HVST121

Mesh back, Black upholstery, Black frame, Height-adjustable arms

LIST PRICE

\$414

BIG & TALL CHAIRS

1-Forty-One



BIG AND TALL

Pneumatic
Swivel
Tilt Tension
Tilt Lock
Adjustable Lumbar
Height-adjustable Arms

DIMENSIONS

Depth:	30 ¹ / ₄	Arm Width:	22 ¹ / ₂
Width:	30 ¹ / ₄	Seat to Floor Height:	19-23
Height:	43	Usable Seat Depth:	20
Seat Depth:	21	Ship Weight:	49 Ⓢ
Seat Width:	22	Cube:	7.0
Back Width:	22	Weight Rating:	350 lbs.
Back Height:	22 ¹ / ₂		

MODEL / DESCRIPTION

HVST141

Black fabric, Height-adjustable arms, Adjustable lumbar

LIST PRICE

\$479

3-Forty-One



BIG AND TALL

Pneumatic
Swivel
Tilt Tension
Tilt Lock
Fixed Padded Arms

DIMENSIONS

Depth:	31 ¹ / ₂	Arm Width:	22 ¹ / ₂
Width:	28 ¹ / ₂	Seat to Floor Height:	19-22
Height:	44 ⁷ / ₈	Usable Seat Depth:	21
Seat Depth:	21	Ship Weight:	56 Ⓢ
Seat Width:	23	Cube:	9.1
Back Width:	23	Weight Rating:	400 lbs.
Back Height:	27		

MODEL / DESCRIPTION

HVST341

Black Bonded Leather

LIST PRICE

\$554

NOW Seating

EXECUTIVE CHAIRS

3-Oh-Three



MID-BACK

Pneumatic
Swivel
Tilt
Tilt Tension
Tilt Lock
Fixed Loop Arms

DIMENSIONS

Depth:	24½	Arm Width:	20
Width:	24½	Seat to Floor Height:	18-23
Height:	39½	Usable Seat Depth:	19½
Seat Depth:	19½	Ship Weight:	31.0 Ⓢ
Seat Width:	20	Cube:	3.7
Back Width:	20	Weight Rating:	225 lbs.
Back Height:	20¼		

MODEL / DESCRIPTION

HVST303

Black Bonded Leather, Fixed loop arms, Black frame

LIST PRICE

\$224

3-Oh-Five



MID-BACK

Pneumatic
Swivel
Tilt
Tilt Tension
Tilt Lock
Fixed Padded Loop Arms

DIMENSIONS

Depth:	25⅝	Arm Width:	19
Width:	36½	Seat to Floor Height:	19-23
Height:	43	Usable Seat Depth:	17
Seat Depth:	17	Ship Weight:	33.0 Ⓢ
Seat Width:	20	Cube:	3.9
Back Width:	20	Weight Rating:	225 lbs.
Back Height:	19		

MODEL / DESCRIPTION

HVST305

Black Bonded Leather, Fixed loop arms, Black frame

LIST PRICE

\$235

3-Fifteen



HIGH-BACK

Pneumatic
Swivel
Tilt
Tilt Tension
Tilt Lock
Fixed Arms

DIMENSIONS

Depth:	31	Arm Width:	19
Width:	28	Seat to Floor Height:	20-25
Height:	47¾	Usable Seat Depth:	18¾
Seat Depth:	18¾	Ship Weight:	43.7 Ⓢ
Seat Width:	19¼	Cube:	6.4
Back Width:	20¾	Weight Rating:	225 lbs.
Back Height:	23½		

MODEL / DESCRIPTION

HVST315

Black Bonded Leather, Silver frame, Padded fixed arms

LIST PRICE

\$325

EXECUTIVE CHAIRS

3-Thirty-One



HIGH-BACK

Pneumatic
Swivel
Multifunction Control
Tilt
Tilt Tension
Tilt Lock
Back Height Adjustment
Height-adjustable Arms

DIMENSIONS

Depth:	24 ³ / ₈	Arm Width:	19 ¹ / ₂
Width:	26 ¹ / ₈	Seat to Floor Height:	17-20
Height:	45 ¹ / ₄	Usable Seat Depth:	17
Seat Depth:	17	Ship Weight:	50.4 Ⓢ
Seat Width:	21	Cube:	6.4
Back Width:	20	Weight Rating:	225 lbs.
Back Height:	25		

MODEL / DESCRIPTION

HVST331

Black Bonded Leather, Black frame, Height-adjustable arms

LIST PRICE

\$392

5-Eleven



MID-BACK

Pneumatic
Swivel
Tilt
Tilt Tension
Tilt Lock
Fixed Loop Arms

DIMENSIONS

Depth:	24 ¹ / ₂	Arm Width:	19
Width:	24 ¹ / ₂	Seat to Floor Height:	17-20
Height:	39 ¹ / ₄	Usable Seat Depth:	18
Seat Depth:	19 ¹ / ₂	Ship Weight:	34.0 Ⓢ
Seat Width:	19	Cube:	4.6
Back Width:	19	Weight Rating:	225 lbs.
Back Height:	22 ³ / ₄		

MODEL / DESCRIPTION

HVST511

Black Bonded Leather, Chrome frame, Chrome fixed arms

LIST PRICE

\$303

NOW Seating

RACING STYLE CHAIRS

9-One-One



HIGH-BACK

Pneumatic
Swivel
Tilt
Tilt Tension
Tilt Lock
Flip-up Arms

DIMENSIONS

Depth:	28½	Arm Width:	20½
Width:	28½	Seat to Floor Height:	18-22
Height:	47½	Usable Seat Depth:	17⅞
Seat Depth:	20¼	Ship Weight:	42.2 Ⓢ
Seat Width:	20¼	Cube:	5.9
Back Width:	19¾	Weight Rating:	225 lbs.

MODEL / DESCRIPTION

HVST911

Black and Gray Bonded Leather, Black frame, Leather padded flip-up arms

LIST PRICE

\$362

WORKPLACE TOOLS CHAIR MATS

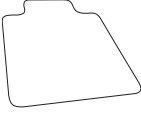
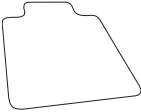
	MODEL	DESCRIPTION	SHIP WEIGHT	CUBE	LIST PRICE
	HCM4660LS	Lipped Chair Mat with Studs 60"W x 46"D	13.9	1.0	\$146
	HCM3648LS	48"W x 36"D	8.8	0.6	\$88
NOTES: Clear finish only. Available in 60"W x 46"D and 48"W x 36"D sizes. Features rectangle and lipped shapes. Available with studs for carpet and without studs for hard-surface floors. Ships rolled. HON 5-Year Limited Warranty. ! Clear finish only. No specification needed.					
	HCM4660LN	Lipped Chair Mat without Studs 60"W x 46"D	13.2	0.5	\$146
	HCM3648LN	48"W x 36"D	8.3	0.3	\$88
NOTES: Clear finish only. Available in 60"W x 46"D and 48"W x 36"D sizes. Features rectangle and lipped shapes. Available with studs for carpet and without studs for hard-surface floors. Ships rolled. HON 5-Year Limited Warranty. ! Clear finish only. No specification needed.					

CROSS REFERENCE INDEX

MODEL	PAGE	MODEL	PAGE	MODEL	PAGE	MODEL	PAGE
H10515R	50	HBSMAUSB	87, 114	HETP5048FP	62	HIWM3	131
H10516L	50	HBTRND36	100	HETP5060FP	62	HIWMMKD	132
H105291	53	HBTTX30S	100	HETP6524FP	63	HIWMRAKD	133
H105292	53	HBTTX42S	100	HETP6530FP	63	HIWMU	133
H105323	51	HBXRISER	101	HETP6536FP	63	HIWMUKD	133
H105324	51	HCLA65	109	HETP6548FP	63	HLCPL29WFH	11
H10534	51	HCLQT	123	HETP6550FP	63	HLCPL29WFH-US	11
H10543	51	HCM3648LN	159	HEVHF07P	68	HLCR2442WFH	9
H10543	51	HCM3648LS	159	HEVHF15P	68	HLCR2448WFH	9
H105532	53	HCM4660LN	159	HEVHF22P	68	HLCR2454WFH	9
H105535	53	HCM4660LS	159	HEWS42P	68	HLCR2442WFH-US	10
H10563	52	HCOMDOME2	83	HEWS50P	68	HLCR2448WFH-US	10
H10565	51	HCTIMM	123	HEWS57P	68	HLCR2454WFH-US	10
H10573	50	HCTL242	72	HEWS65P	68	HLDA-15	109
H10583R	50	HEC42PLN	67	HFLMC1	127	HLDV-M3A	109
H10584L	50	HEC42PTN	67	HFLSC1	127	MLDV-MRECT2026A	109
H105856	51	HEC42PXN	67	HFLY01	128	HLED17AS	52, 118
H105895R	49	HEC50PLN	67	HGV1MM	129	HLED31AS	52, 118
H105896L	49	HEC50PTN	67	HH870070	86	HLPLB3624	19
H105905R	49	HEC50PXN	67	HH870930	52, 118	HLPLB4224	19
H105906L	49	HEC57PLN	67	HH870942	52, 118	HLPLB4824	19
H105905R	49	HEC57PTN	67	HH871124	85	HLPLBC3013B2	27
H105906L	49	HEC57PXN	67	HH871130	85	HLPLBC3013B4	27
H10593	50	HEC65PLN	67	HH871136	85	HLPLBC3013B5	27
H15923A	64, 84, 93	HEC65PTN	67	HH871148	85	HLPLCL3020BF	33
H2095	138	HEC65PXN	67	HH871160	85	HLPLCL3020S	33
H2285	135	HECB01	71	HH871224	85	HLPLCL3020TOP	35
H312	95	HECB42	71	HH871230	85	HLPLCL3620BF	33
H314	95	HECPP	86	HH871236	85	HLPLCL3620S	33
H315	95	HECS1	67	HH871248	85	HLPLCL3620TOP	35
H33723R	90	HECSL	67	HH871260	85	HLPLCL6020TOP	34
H33823R	90	HECST	67	HH871400	85	HLPLCL6620TOP	34
H4008	142	HECSX	67	HH871500	85	HLPLCL7720TOP	34
H4031	130	HECVH07P	68	HH871501	86	HLPLCS30	20
H512	96	HECVH15P	68	HH871502	86	HLPLCS36	20
H514	96	HECVH22P	68	HH871503	86	HLPLCS4824	17
H5701	148	HEFEC42P	68	HH871504	86	HLPLCS6024	17
H5703	148	HEFEC50P	68	HH871912	85	HLPLCS6624	17
H5705	148	HEFEC57P	68	HH879072	85	HLPLCS7224	16
H5711	149	HEFEC65P	68	HHAB2S2L	101	HLPLCSEAT3020	35
H5715	149	HEOHTA1530FD	64	HHAB3S2L	101	HLPLCSEAT3620	35
H5795	148	HEOHTA1536FD	64	HHABETA2S2L	101	HLPLDH60	21
H682	92	HEOHTA1548FD	64	HHAW2448P	102	HLPLDH66	21
H683	92	HEOHTA1560FD	64	HHAW2460P	102	HLPLDH72	21
H684	92	HEOHTA1572FD	64	HHAW2460PN	79	HLPLDR12MB	24
H872	91	HES1524G	66	HHAW3060PN	102	HLPLDR48GS	23
H919491	97	HES1530G	66	HHC-FOOTPULL15	118	HLPLDR48LM	23
H919492	97	HES1536G	66	HHC-FOOTPULL5	118	HLPLDR60GS	23
HACRYEXSCRN2042	117	HES1548G	66	HHC-PPESTND	115	HLPLDR60LM	23
HACRYEXSCRN2536	117	HES1560G	66	HHC-SANSTND	115	HLPLDR66GS	23
HACRYSCRN2524	117	HESHRTA30	64	HHC-TASCRN3630	117	HLPLDR66LM	23
HACRYSCRN2530	117	HESHRTA36	64	HHC-TASCRN3636	117	HLPLDR72GS	23
HACRYSCRN2536	117	HESHRTA48	64	HHN831124	72	HLPLDR72LM	23
HACRYSCRN2548	117	HESHRTA60	64	HHN831130	72	HLPLDS4830	16
HACRYSCRN2554	117	HETC24	66	HHTADF3	86	HLPLDS6030	16
HACRYSCRN2560	117	HETC30	66	HHTADF4	86	HLPLDS6630	15
HACRYSCRN2566	117	HETC36	66	HHTADJ5	86	HLPLDS7230	15
HAPMBS239TFN	94	HETC48	66	HHTADJ6	86	HLPLDS7236	15
HAUFHR15N	94	HETC60	66	HHUD2460FLB9	104	HLPLDS7236B	15
HBCSRI536P	70	HETP4224FP	62	HHUD2460FLC	104	HLPLFB24	32
HBCSRI548P	70	HETP4230FP	62	HHUD2460FXB9	104	HLPLLEG24A	32
HBCSRI560P	70	HETP4236FP	62	HHUD2460FXC	104	HLPLLEG24U	32
HBCSRI572P	70	HETP4248FP	62	HICS7	134	HLPLLEG30A	32
HBDMAUSB	115	HETP4260FP	62	HIEH1	131	HLPLLEG30U	32
HBLPBRIDGE	54	HETP5024FP	62	HIGS6	134	HLPLLF3620L2	29
HBPLCLASSIC	54	HETP5030FP	62	HITS5	131	HLPLLF3620L3	28
HBLPCONTEMP	54	HETP5036FP	62	HITSM	132	HLPLLF3620L4	28

CROSS REFERENCE INDEX

MODEL	PAGE	MODEL	PAGE	MODEL	PAGE	MODEL	PAGE
HLPLOS10	32	HLSLPBR	65	HSS4L-18B	111	HVST305	156
HLPLOS23	32	HLSLR2448	43	HSSA-WB1618	111	HVST315	156
HLPLPEN6630	20	HLSLR3060	43	HSSST-18B	111	HVST331	157
HLPLPEN7236	20	HLSLR3066	43	HSSSTK-18B	111	HVST341	155
HLPLPHBF	25	HLSLR3072	43	HSWEEPA2	54	HVST511	157
HLPLPMBBF	26	HLSLZ5SC54	44	HSWEEPA3	54	HVST911	158
HLPLPMBF	26	HLSLZ5SC60	44	HSWEEPC2	54	HWCS3624P	70
HLPLPMFF	26	HLSLZ5SC66	44	HSWEEPC3	54	HWR2430P	69
HLPLPSBBF	25	HLSLZ5SC72	44	H-TASCRN3630	117	HWR2436P	69
HLPLPSEAT1520	26	HLTV2460-3	110	H-TASCRN3636	117	HWR2448P	69
HLPLPSFF	25	HLVMSC4330R	110	HTLC3672	106	HWR2460P	69
HLPLRCPNDS7230	40	HMASD	115	HTLD48	106	HWR2460PN	79
HLPLRCPNRS4225	40	HMBFLIP24L	103	HTTLEG72	106	HWR2472P	69
HLPLRCPNTPGS	40	HMBTLEG24	103	HTXLEG	106	HWR3048P	69
HLPLRCPNTPLM	40	HML8851	105	HVFB23R	73	HWR3060P	69
HLPLRS3624	18	HML8852	105	HVFF23R	73	HWR3060PN	79
HLPLRS4224	18	HMN2	136	HVL102	145	HWR3072P	69
HLPLRS4824	18	HMP144	83	HVL103	145	HWSB2	72
HLPLRW4824	31	HMPDFS4813	82	HVL105	151		
HLPLRW4830	31	HMPDFS6013	82	HVL108	126		
HLPLRW6024	30	HMPDFS2413	81	HVL151	151		
HLPLRW6030	30	HMPDL4828	78	HVL210	147		
HLPLRW6624	30	HMPFSS4813	82	HVL215	147		
HLPLRW7224	29	HMPFSS5413	82	HVL232	135		
HLPLRW7230	29	HMPFSS6013	82	HVL238	136		
HLPLSC3620	27	HMPHASLID60	80	HVL281	137		
HLPLSL24	32	HMPHATROUGH60	80	HVL282	137		
HLPLSL30	32	HMPHAWTWML	83	HVL283	137		
HLPLTACK48	24	HMPPPP125	83	HVL289	137		
HLPLTACK60	24	HMPSL4828	78	HVL303	153		
HLPLTACK72	24	HMPT2460NS	100	HVL304	120		
HLPLTBL120BASE	39	HMPT2472NS	100	HVL314	120		
HLPLTBL3672RCT	38	HMPTROUGH60	80	HVL511	144		
HLPLTBL36RND	36	HMPUB260	78	HVL515	144		
HLPLTBL36BASE	37	HMPVWM28	83	HVL518	135		
HLPLTBL4296RCT	38	HMS1	136	HVL521	152		
HLPLTBL42BASE	37	HMT2460G	103	HVL531	139		
HLPLTBL42RND	36	HMVPCA1-1830G	108	HVL532	139		
HLPLTBL48120RCT	38	HMVPCSS-4C4C	108	HVL534	140		
HLPLTBL48BASE	37	HOLEG24	71	HVL539	140		
HLPLTBL48RND	36	HOLEG30	71	HVL541	126		
HLPLTBL72BASE	39	HPD2PNBRK2L	72	HVL581	125		
HLPLTBL96BASE	39	HPD2PNBRK2R	72	HVL582	125		
HLPLW1824	28	HPNLSTACK2224	116	HVL585	125		
HLPLW2424	28	HPNLSTACK2230	116	HVL601	152		
HLPLWMH48	22	HPNLSTACK2236	116	HVL605	146		
HLPLWMH60	22	HPNLSTACK2242	116	HVL606	142		
HLPLWMH66	22	HPNLSTACK2248	116	HVL616	142		
HLPLWMH72	22	HPNLSTACK2254	116	HVL653	152		
HLPLXS60	31	HPNLSTACK2260	116	HVL693	122		
HLPLXS66	31	HPSEAT24ND	64, 84, 93	HVL701	150		
HLPLXS72	31	HPWRMOD2WC	87	HVL702	150		
HLSL2016MP2	47, 84	HRUCK1L	141	HVL705	150		
HLSL2016PH2	47, 84	HRUCK5L	141	HVL712	150		
HLSL2060LD2	46	HRVC35PCE	73	HVL721	126		
HLSL2428B	45	HRVCLG24	71	HVL871	121		
HLSL2428O	44, 65	HRVCLG30	71	HVL872	121		
HLSL28AM2	45	HRVEP2429L	71	HVL873	121		
HLSL3028O	44, 65	HRVEP2429R	71	HVL887	124		
HLSL3028SL	44	HRVEP3029L	71	HVL888	124		
HLSL307O	44	HRVEP3029R	71	HVL995	147		
HLSL4214MM	46	HSCKTPS	67	HVST101	154		
HLSL4814MM	46	HSGS6	120	HVST102	154		
HLSL5414MM	46	HSLVSMM	143	HVST121	155		
HLSL6014MM	46	HSLVTMMKD	143	HVST141	155		
HLSLPBL	65	HSLVTMR	143	HVST303	156		

HON NOW FULL LIFETIME WARRANTY INFORMATION



FULL LIFETIME WARRANTY

YOUR HON FULL LIFETIME WARRANTY

Every time you purchase a HON product, you're making an investment in your future. We're proud to play a part in that future, and you can trust us to do our best for as long as you need us.

The HON Full Lifetime Warranty is our assurance to you that the HON desks, workstations, seating, tables, or storage you purchase will be free from defective material or workmanship for the life of the product.

In the unlikely event that any HON product or component covered by the HON Full Lifetime Warranty should fail under normal workplace use as a result of defective material or workmanship, HON shall repair or replace with comparable product (at HON's discretion), free of charge.

WHAT'S COVERED BY THE HON FULL LIFETIME WARRANTY?

Your HON Full Lifetime Warranty applies to product manufactured after January 1, 2011. All HON product lines, materials, and components are covered by the HON Full Lifetime Warranty except for the items described below.

The specific product lines, materials, and components listed below are covered under HON's Full 12-Year, Full 10-Year, and Full 5-Year Warranties (from date of purchase).

HON'S FULL 12-YEAR WARRANTY

- Electrical components (LED task lights, lamps and ballasts are not covered)
- 4-Way Stretch
- Seating controls
- Pneumatic Cylinders
- Accessories
- Laminate Surfaces

HON'S FULL 5-YEAR WARRANTY

- All LED task lights
- Panel and seating textiles
- Electric Height-Adjustable Bases (Including Memory Control)
- Coordinate™ Desktop Sit-to-Stand Risers

These warranties apply to HON products sold within the United States of America, U.S. Territories, and Canada, as well as U.S. Military and Federal Agency purchases (regardless of location).

IS ANYTHING NOT COVERED?

There are a few exclusions to the HON Full Lifetime Warranty and to the 12-, 10-, and 5-year warranties. These exclusions are:

- All HON products that are covered under a separate 5-year warranty.
- Color-fastness or matching of colors, woodgrains, or textures occurring in wood, leather, or other materials that naturally exhibit inherent color variations.
- Customer's own materials (COM) selected by and used at the request of the user.
- Modifications or attachments to the product that are not approved by The HON Company and product failures resulting from such modifications or attachments.
- Product normal wear and tear, which are to be expected over the course of ownership.
- Products that were not installed, used, or maintained in accordance with product instructions and warnings.
- Products used for rental purposes.
- Damage caused by cleaning chemicals.
- Dye transfer caused by external contaminants (including clothing and accessory dyes such as those used on denim jeans) may migrate to lighter colors. This phenomenon is increased by humidity and temperature and is irreversible.
- Fabric pattern match seat to back or chair to chair. If pattern match is needed, please submit a Tailored Solutions request or contact HON Customer Support/Tailored Solutions with questions.

WARRANTY REQUESTS OR QUESTIONS?

Your HON Dealer is our mutual partner in supporting your warranty requests. To obtain service under this warranty, please contact your HON dealer. If you are not sure who your dealer is, please call HON Customer Support at 800.833.3964.

THAT'S YOUR HON FULL LIFETIME WARRANTY AS AN OWNER OF HON PRODUCT, THE WARRANTY EXPLAINED HERE IS YOUR SOLE AND EXCLUSIVE REMEDY. THERE ARE SOME EXCEPTIONS IF YOU PURCHASED THE PRODUCT FOR HOME OR PERSONAL USE WHICH ARE EXPLAINED BELOW. TO THE EXTENT ALLOWED BY LAW, THE HON COMPANY MAKES NO OTHER WARRANTY, EITHER EXPRESS OR IMPLIED, INCLUDING ANY WARRANTY OF MERCHANTABILITY OR FITNESS FOR A PARTICULAR PURPOSE. THE HON COMPANY WILL NOT BE LIABLE FOR ANY CONSEQUENTIAL OR INCIDENTAL DAMAGES.

A WORD ABOUT PURCHASES FOR HOME OR PERSONAL USE

Please note, this section only applies if you purchased your HON product for your home or for your own personal or family use. HON's warranties give you specific legal rights and you may have other rights, which vary from state to state. As a consumer purchaser, the complete exclusion of implied warranties noted in the above paragraph does not apply to you, however, to the extent allowed by applicable state law, the implied warranties are limited to the applicable term of the warranty. Some states do not allow the exclusion or limitation of incidental or consequential damages, so the above exclusion or limitation may not apply to you.

HON LIMITED 5-YEAR WARRANTY INFORMATION



LIMITED 5-YEAR WARRANTY

The HON Company promises to repair or replace HON products or components covered under this warranty that are found to be defective in material or workmanship within five (5) years from the date of original purchase so long as you, the original purchaser, still owns it. This is your sole and exclusive remedy. This warranty is subject to the provisions below. It applies to the products listed here manufactured after January 1, 2018.

LIMITATIONS:

- Upholstery on chairs is warranted for two years from date of purchase.
- Damage caused by the carrier in-transit is handled under separate terms.

EXCLUSIONS:

This warranty does not apply and no other warranty applies to:

- Normal wear and tear, which are to be expected over the course of ownership.
- Modifications or attachments to the product that are not approved by The HON Company.
- Products that were not installed, used or maintained in accordance with product instructions and warnings.
- Products used for rental purposes.

SEATING USAGE

Normal commercial use for seating is identified as the equivalent of a single shift, forty-(40) hour workweek. To the extent that a seating product is used in a manner exceeding this, the applicable warranty period will be reduced in a pro-rata manner.

A WORD ABOUT COLOR VARIATIONS, FABRICS AND FINISHES:

The HON Company does not warrant the color-fastness or matching of colors, grains or textures of covering materials.

CUSTOMER'S OWN MATERIAL (COM)

Not available on HON products covered under the HON 5-year warranty.

TO THE EXTENT ALLOWED BY LAW, THE HON COMPANY MAKES NO OTHER WARRANTY, EITHER EXPRESS OR IMPLIED, INCLUDING ANY WARRANTY OF MERCHANTABILITY OR FITNESS FOR A PARTICULAR PURPOSE. THE HON COMPANY WILL NOT BE LIABLE FOR ANY CONSEQUENTIAL OR INCIDENTAL DAMAGES.

NOTICE TO PURCHASERS FOR HOME OR PERSONAL USE:

Federal law does not permit the exclusion of certain implied warranties for consumer products. Therefore, if you are purchasing this product for home or personal use, the exclusion of implied warranties noted in the above paragraph does not apply to you. Some states do not allow the exclusion or limitation of incidental or consequential damages, so the above limitation or exclusion may not apply to you. This warranty gives you specific legal rights, and you may also have other rights which vary from state to state.

This warranty applies only to products sold within the United States of America and the Commonwealth of Canada.

TO OBTAIN SERVICE UNDER THIS WARRANTY:

Your HON® Dealer is our mutual partner in supporting your warranty requests. By following the procedures outlined below, you can be assured of the best level of service. Please note: Consent of The HON Company must be obtained before any warranty work is performed. To obtain consent, please take the following steps:

1. Contact the Dealer from whom the product was purchased within 30 days of discovery of the defect. Be prepared to affirm that you are the original purchaser of the product and to provide the serial number(s) from the product in question.
2. Your Dealer will gather all pertinent information regarding the claim, inspect the product and contact a HON Company customer service representative. (Please allow a reasonable amount of time for inspection and review.)
3. If The HON Company affirms that the product in question is eligible under the conditions of the warranty as stated above, the customer service representative or another representative of the Company will determine whether to provide replacement parts, authorize repairs or replace the product.